

ÉLÉMENTS ENCASTRABLES INTÉRIEURS ET EXTÉRIEURS

INDOOR AND
OUTDOOR RECESSED LIGHTS

- **HOLLY** 60
- **HALISSA** 60
- **MEMO** 61
- **DEHO 2** 62
- **DEHO Q** 62
- **DEHO 3** 63
- **DEHO 4** 63
- **DEHO 316 LQ** 64
- **DEHO 316 LT** 64
- **DARDO 2** 65
- **DARDO Q** 65
- **DARDO 3** 66
- **ACSO 1** 67
- **ACSO 2** 68
- **ACSO 3** 68
- **ACRUX 1 COB** 69

HOLLY

L30R.

Élément encastrable en acier tourné AISI 304 avec POWER LED.
Pour l'éclairage d'accentuation, ou balisage de service au sol et au mur. Pour les espaces intérieurs et extérieurs.

- Montage avec ressort ou boîtier d'encastrement.
- Optique secondaire au choix.
- Alimentation: 350mA
- Câble: 50cm

À CONNECTER EN SÉRIE

*Turned steel recessed AISI 304 spot with POWER LED.
It is suitable as accent lighting or as wall or floor service steplight.
It can be installed on indoor or outdoor locations.*

- Spring or outer casing assembly.
- Choice of secondary optic.
- Power supply: 350mA
- Cable: cm. 50

CONNECT IN SERIES



HALISSA

L30Q.

Élément encastrable en acier tourné AISI 304 avec POWER LED.
Pour l'éclairage d'accentuation, ou balisage de service au sol et au mur. Pour les espaces intérieurs et extérieurs.

- Montage avec ressort ou coffrage.
- Optique secondaire au choix.
- Alimentation: 350mA
- Câble: 50cm

À CONNECTER EN SÉRIE

*Turned steel recessed AISI 304 spot with POWER LED.
It is suitable as accent lighting or as wall or floor service steplight.
It can be installed on indoor or outdoor locations.*

- Spring or outer casing assembly.
- Choice of secondary optic.
- Power supply: 350mA
- Cable: cm. 50

CONNECT IN SERIES

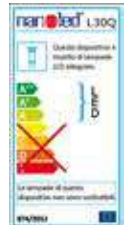

DIMENSIONS / DIMENSIONS

L30R.

L30Q.

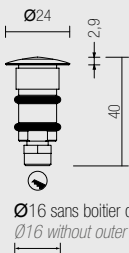

Ø16 sans boîtier d'enc.
Ø16 without outer casing

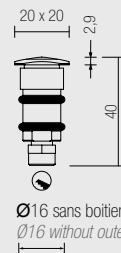

Ø16 sans boîtier d'enc.
Ø16 without outer casing

ACCESSOIRES / ACCESSORIES



Boîtier enc. 548/20 p. 297
Outer casing 548/20 page 297



Ressort A18-063
Spring A18-063

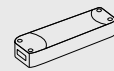

Ballasts (p. 262).
Drivers page 262

CODES DE BASE / BASE CODES

FAISCEAU LUMINEUX / LIGHT BEAM

VERRE / GLASS

COULEUR LED / LED COLOR

PUISSANCE / POWER

L30R.
L30Q.

- ▲ 25 25°
- ▲ 40 40°
- ▲ 60 60°

- T Transparent
Transparent
- S Sablé
Sandblasted

- BN 4000°K
- BC 3000°K
- CC 2700°K
- BL Bleu / Blue
- VE Vert / Green
- RO Rouge / Red

1x1W - 350mA - 141 lum

Exemple de codification : Article HOLLY + Faisceau lumineux 25° + Verre transparent + Couleur led 3000°K = Code : L30R.25TBC
Example of codification: Product HOLLY + Light beam 25° + Glass transparent + Led color 3000°K = Code: L30R.25TBC

MEMO L30S.

Élément encastrable en acier tourné AISI 304 avec POWER LED et protection contre l'éblouissement.

Pour l'éclairage d'accentuation, ou balisage de service au sol ou au mur. Pour les espaces intérieurs et extérieurs.

- Montage avec ressort ou boîtier d'encastrement.
- Diffusion radiale.
- Alimentation: 350mA
- Câble : 50cm

À CONNECTER EN SÉRIE

Turned steel recessed AISI 304 spot with POWER LED and with antiglare protection.

It is suitable as accent lighting or as wall or floor service spotlight. It can be installed on indoor or outdoor locations.

- *Spring or outercasing assembly.*
- *Radial diffusion.*
- *Power supply: 350mA*
- *Cable: cm. 50*

CONNECT IN SERIES

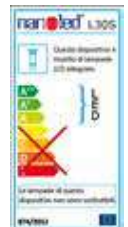
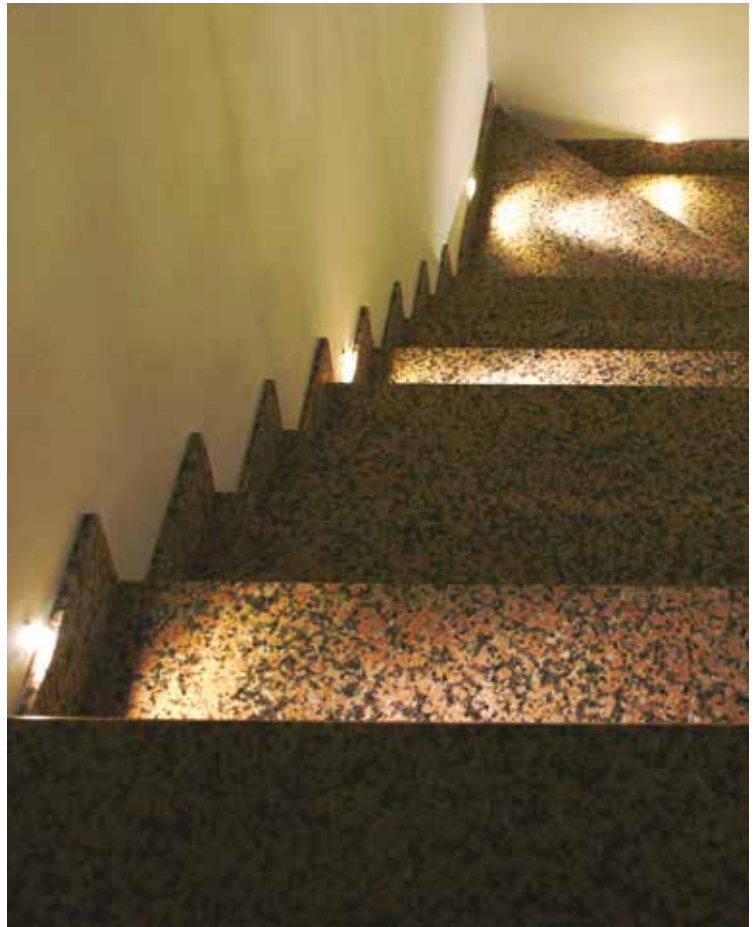

DIMENSIONS / DIMENSIONS



ACCESSOIRES / ACCESSORIES



CODES DE BASE / BASE CODES

L30S.

FAISCEAU LUMINEUX / LIGHT BEAM

R1 Radial 1 ouverture
Radial 1 opening

VERRE / GLASS

T Transparent
Transparent
S Sablé
Sandblasted

COULEUR LED / LED COLOR

BN 4000°K
BC 3000°K
CC 2700°K
BL Bleu / Blue
VE Vert / Green
RO Rouge / Red

PUISSANCE / POWER

1x1W - 350mA - 141 lum

Exemple de codification : Article MEMO + Faisceau lumineux radial 1 ouverture + Verre sablé + Couleur led 3000°K = Code : **L30S.R1SBC**
Example of codification: Product MEMO + Light beam radial 1 opening + Glass sandblasted + Led color 3000°K = Code: L30S.R1SBC

DEHO 2

L402.

Élément encastrable en acier tourné AISI 304 avec POWER LED.
Pour l'éclairage d'accentuation, ou balisage de service au sol ou au mur. Pour les espaces intérieurs et extérieurs.

- Installation avec boîtier d'encastrement.
- Optique secondaire au choix.
- Alimentation: 350/500mA
- Câble: 50cm

À CONNECTER EN SÉRIE

Turned steel recessed AISI 304 spot with POWER LED.

It is suitable as accent lighting or as wall or floor service spotlight. It can be installed on indoor or outdoor locations.

- Outercasing assembly.
- Choice of secondary optic.
- Power supply: 350/500mA
- Cable: cm. 50

CONNECT IN SERIES



DEHO Q

L405.

Élément encastrable en acier tourné AISI 304 avec POWER LED.
Pour l'éclairage d'accentuation, ou balisage de service au sol ou au mur. Pour les espaces intérieurs et extérieurs.

- Installation avec boîtier d'encastrement.
- Optique secondaire au choix.
- Alimentation: 350/500mA
- Câble : 50cm

À CONNECTER EN SÉRIE

Turned steel recessed AISI 304 spot with POWER LED.

It is suitable as accent lighting or as wall or floor service spotlight. It can be installed on indoor or outdoor locations.

- Outercasing assembly.
- Choice of secondary optic.
- Power supply: 350/500mA
- Cable: cm. 50

CONNECT IN SERIES



DIMENSIONS / DIMENSIONS

ACCESSOIRES / ACCESSORIES

L402.

L405.

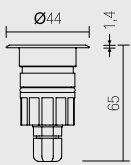

Ø32 sans boîtier d'enc.
Ø32 without outer casing

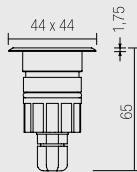

Ø32 sans boîtier d'enc.
Ø32 without outer casing

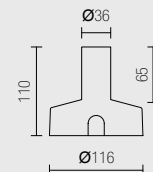

Boîtier d'enc. 548/40 p. 296
Outer casing 548/80 page 296

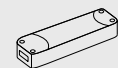

Ballasts p. 262-263
Drivers page 262-263

CODES DE BASE / BASE CODES

FAISCEAU LUMINEUX / LIGHT BEAM

VERRE / GLASS

COULEUR LED / LED COLOR

PUISSANCE / POWER

L402.
L405.

- 15 15°
- ▲ 25 25°
- ▲ 40 40°
- ▲ 60 60°
- ▲ 80 80°

- T Transparent / Transparent
- S Sablé / Sandblasted
- B Blanc / White

- BN 4000°K
- BC 3000°K
- CC 2700°K
- BL Bleu / Blue
- VE Vert / Green
- RO Rouge / Red

- 3 1x1W 350mA - 141lm
- 5 1x2W 500mA - 176 lm

Exemple de codification : Article DEHO 2 + Faisceau lumineux 25° + Verre transparent + Couleur led 3000°K + Puissance 1x1W 350mA = Code : L402.25TBC3
Example of codification: Product DEHO 2 + Light beam 25° + Glass transparent + Led color 3000°K + Power 1X1W 350mA = Code: L402.25TBC3

DEHO 3

L403.

Élément encastrable en acier tourné AISI 304 avec POWER LED et protection contre l'éblouissement. Pour l'éclairage d'accentuation, ou balisage de service au sol ou au mur.

Pour les espaces intérieurs et extérieurs.

- Installation avec boîtier d'encastrement.
- Diffusion radiale avec polycarbonate opale
- Alimentation: 350/500mA
- Câble: 50cm

À CONNECTER EN SÉRIE

Turned steel recessed AISI 304 spot with POWER LED and with antiglare protection. It is suitable as accent lighting or as wall or floor service spotlight. It can be installed on indoor or outdoor locations.

- *Outercasing assembly.*
- *Radial diffusion with opal polycarbonate*
- *Power supply: 350/500mA*
- *Cable: cm. 50*

CONNECT IN SERIES

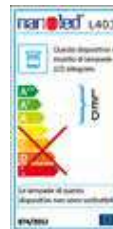

DEHO 4

L404.

Élément encastrable en acier tourné AISI 304 avec POWER LED et protection contre l'éblouissement. Pour l'éclairage d'accentuation ou comme balise de service au sol ou au mur.

Pour les espaces intérieurs et extérieurs.

- Installation avec boîtier d'encastrement.
- Diffusion radiale avec polycarbonate opale.
- Alimentation: 350/500mA
- Câble: 50cm

À CONNECTER EN SÉRIE

Turned steel recessed AISI 304 spot with POWER LED and with antiglare protection. It is suitable as accent lighting or as wall or floor service spotlight. It can be installed on indoor or outdoor locations.

- *Outercasing assembly.*
- *Radial diffusion with opal polycarbonate*
- *Power supply: 350/500mA*
- *Cable: cm. 50*

CONNECT IN SERIES



DIMENSIONS / DIMENSIONS

L403.

L404.

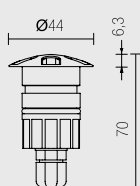
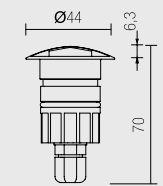

Ø32 sans boîtier d'enc.
Ø32 without outer casing

Ø32 sans boîtier d'enc.
Ø32 without outer casing

ACCESSOIRES / ACCESSORIES

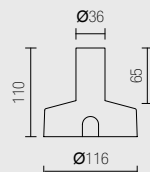

Boîtier d'enc. 548/40 p. 296
Outer casing 548/80 page 296

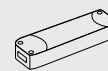

Ballasts p. 262-263
Drivers page 262-263

CODES DE BASE / BASE CODES

FAISCEAU LUMINEUX / LIGHT BEAM

COULEUR LED / LED COLOR

PUISSANCE / POWER

L403.

L404.

- R1 Radial 1 ouverture L403
Radial 1 opening L403
- R5 Radial 5 ouvertures L404
Radial 5 openings L404

- BN 4000°K
- BC 3000°K
- CC 2700°K
- BL Bleu / Blue
- VE Vert / Green
- RO Rouge / Red

3 1x1W - 350mA - 141lm
5 1x2W - 500mA - 176 lm

Exemple de codification : Article DEHO 3 + Faisceau lumineux radial 1 ouverture + Couleur led 3000°K + Puissance 1x1W 350mA = Code : L403.R1TBC3
Example of codification: Product DEHO 3 + Light beam radial 1 opening + Led color 3000°K + Power 1x1W 350mA = Code: L403.R1TBC3

DEHO 316LQ

L416Q.

Élément encastrable en acier 316L tourné avec LED WICOP.
Pour l'éclairage d'accentuation, de décoration ou de courtoisie.
Excellente résistance à la corrosion.

- Pour les espaces intérieurs et extérieurs.
- Installation avec boîtier d'encastrement.
- Diffusion radiale avec polycarbonate opale.
- Alimentation : 12Vcc
- Câble: 50cm

À CONNECTER EN PARALLÈLE

*Turned 316L steel recessed spot with WICOP LED.
It is suitable as accent lighting, as decoration or as curtesy light.*

- *It can be installed on indoor or outdoor locations.*
- *Outercasing assembly.*
- *Radial diffusion with opal polycarbonate.*
- *Power supply: 12Vdc*
- *Cable: cm. 50*

CONNECT IN PARALLEL



DEHO 316LT

L416.

Élément encastrable en acier 316L tourné avec LED WICOP.
Pour l'éclairage d'accentuation, de décoration ou de courtoisie.
Excellente résistance à la corrosion.

- Pour les espaces intérieurs et extérieurs.
- Installation avec boîtier d'encastrement.
- Diffusion radiale avec polycarbonate opale
- Alimentation : 12Vcc
- Câble: 50cm

À CONNECTER EN PARALLÈLE

*Turned 316L steel recessed spot with WICOP LED.
It is suitable as accent lighting, as decoration or as curtesy light.*

- *It can be installed on indoor or outdoor locations.*
- *Outercasing assembly.*
- *Radial diffusion with opal polycarbonate.*
- *Power supply: 12Vdc*
- *Cable: cm. 50*

CONNECT IN PARALLEL



DIMENSIONS / DIMENSIONS

ACCESSOIRES / ACCESSORIES

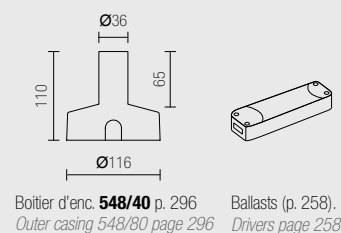
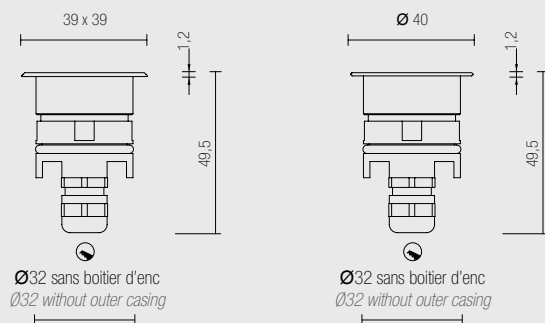

CODES DE BASE / BASE CODES

COULEUR LED / LED COLOR

PUISSANCE / POWER

L416Q.
L416.

- BN** 4000°K
- BC** 3000°K
- CC** 2700°K

2W - 12 Vcc - 216 lm

Exemple de codification : Article DEHO 316LQ + Couleur led 4000°K = Code : **L416Q.BN**
Example of codification: Product DEHO 316LT + Led color 4000°K = Code: L416Q.BN

DARDO 2

L502.

Élément encastrable en acier tourné AISI 304 avec POWER LED.
Pour l'éclairage principal au sol pour les jardins et les façades architecturales.

Pour les espaces intérieurs et extérieurs.

- Installation avec boîtier d'encastrement.
- Optique secondaire au choix.
- Alimentation: 350/500mA
- Câble : 50cm

À CONNECTER EN SÉRIE

Turned steel recessed spot AISI 304 with POWER LED.

It is suitable as main floor lighting for gardens and architectural façades.

It can be installed on indoor or outdoor locations.

- *Outercasing assembly.*
- *Choice of secondary optic.*
- *Power supply: 350/500mA*
- *Cable: cm. 50*

CONNECT IN SERIES

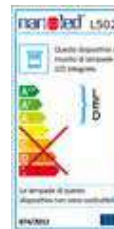

DARDO Q

L504.

Élément encastrable en acier tourné AISI 304 avec POWER LED.
Pour l'éclairage principal au sol pour les jardins et les façades architecturales.

Pour les espaces intérieurs et extérieurs.

- Installation avec boîtier d'encastrement.
- Optique secondaire au choix.
- Alimentation: 350/500mA
- Câble : 50cm

À CONNECTER EN SÉRIE

Turned steel recessed spot AISI 304 with POWER LED.

It is suitable as main floor lighting for gardens and architectural façades. It can be installed on indoor or outdoor locations.

- *Outercasing assembly.*
- *Choice of secondary optic.*
- *Power supply: 350/500mA*
- *Cable: cm. 50*

CONNECT IN SERIES

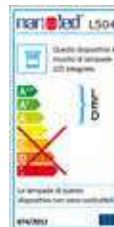

DIMENSIONS / DIMENSIONS

L502.

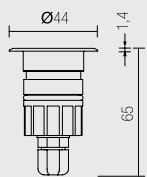

Ø32 sans boîtier d'enc
Ø32 without outer casing

L504.

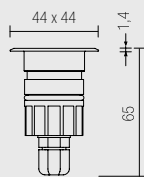

Ø32 sans boîtier d'enc
Ø32 without outer casing

ACCESSOIRES / ACCESSORIES

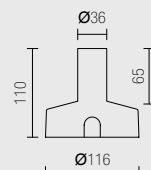

Boîtier d'enc 548/40 p. 296
Outer casing 548/80 page 296

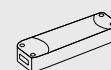

Ballasts p. 262-263
Drivers page 262-263

CODES DE BASE /
BASE CODES

FAISCEAU LUMINEUX /
LIGHT BEAM

VERRE / GLASS

COULEUR LED / LED COLOR

PUISSANCE / POWER

L502.
L504.

■ 15 15°
■ 25 25°
■ 35 35°

■ T Transparent / Transparent
■ S Sablé / Sandblasted
■ B Blanc / White

■ BN 4000°K
■ BC 3000°K
■ CC 2700°K
■ BL Bleu / Blue
■ VE Vert / Green
■ RO Rouge / Red

■ 3 3x1W - 350mA - 423 lm
■ 5 3x2W - 500mA - 528 lm

Exemple de codification : Article DARDO 2 + Faisceau lumineux étroit 15° + Verre transparent + Couleur led 3000°K + Puissance 3x1W 350mA = Code : L502.15TBC3

Example of codification: Product DARDO 2 + Light beam 15° + Glass transparent + Led color 3000°K + Power 3X1W 350mA = Code: L502.15TBC3

DARDO 3

L503.

Élément encastrable en acier tourné AISI 304 avec POWER LED et protection contre l'éblouissement.

Pour l'éclairage d'accentuation, ou balisage de service au sol ou au mur. Pour les espaces intérieurs et extérieurs.

- Montage boîtier d'encastrement.
- Diffusion radiale avec polycarbonate opale.
- Alimentation: 350/500mA
- Câble : 50cm

À CONNECTER EN SÉRIE

Turned steel recessed spot with POWER LED and with antiglare protection.

It is suitable as accent lighting or as wall or floor service spotlight. It can be installed on indoor or outdoor locations.

- *Outercasing assembly.*
- *Radial diffusion with opal polycarbonate.*
- *Power supply: 350/500mA*
- *Cable: cm. 50*

CONNECT IN SERIES

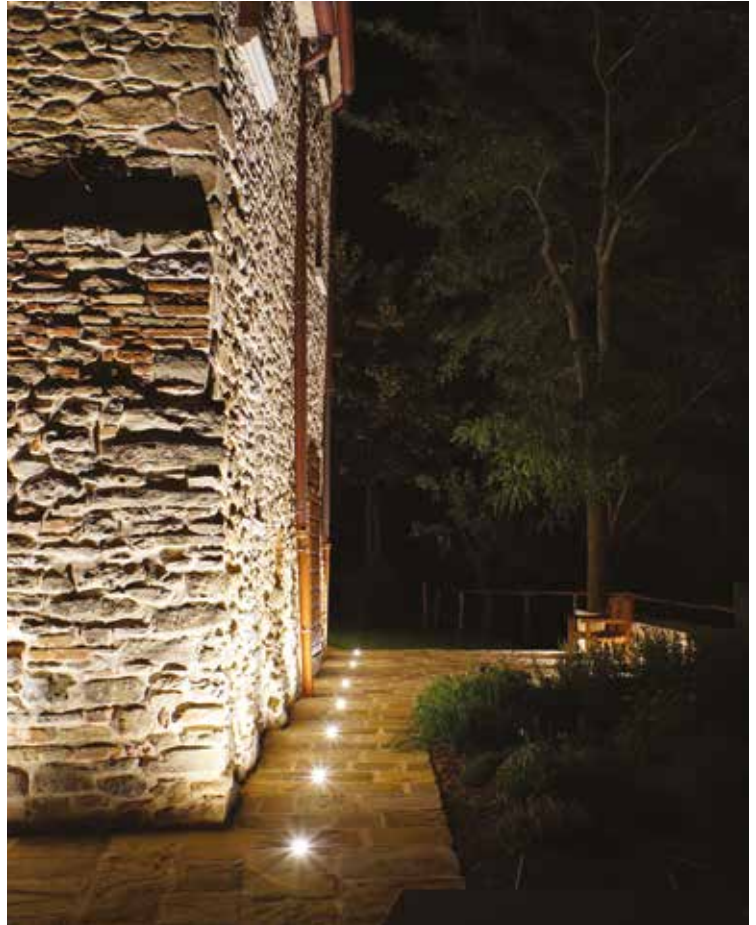

DIMENSIONS / DIMENSIONS

ACCESSOIRES / ACCESSORIES

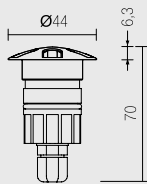

Ø32 sans boîtier d'enc
Ø32 without outer casing

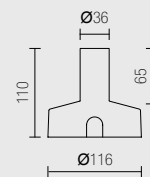

Boîtier d'enc 548/40 p. 296
Outer casing 548/80 page 296

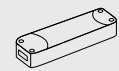

Ballasts p. 262-263
Drivers page 262-263

CODES DE BASE / BASE CODES

FAISCEAU LUMINEUX / LIGHT BEAM

COULEUR LED / LED COLOR

PUISSANCE / POWER

L503.

- R5 Radial 5 ouvertures
Radial 5 opening

- BN 4000°K
- BC 3000°K
- CC 2700°K
- BL Bleu / Blue
- VE Vert / Green
- RO Rouge / Red

- 3 3x1W - 350mA - 423 lm
- 5 3x2W - 500mA - 528 lm

Exemple de codification : Article DARDO 3 + Faisceau lumineux radial 5 ouvertures + Verre transparent + Couleur led 4000°K + Puissance 3x1W 350mA = Code : L503.R5TBN3
Example of codification: Product DARDO 3 + Light beam radial 5 openings + Glass transparent + Led color 4000°K + Power 3X1W 350mA = Code: L503.R5TBN3

ACSO 1

L601.

Élément encastrable en acier tourné AISI 304 avec POWER LED.
Pour l'éclairage principal au sol pour les jardins et les façades architecturales.

Pour les espaces intérieurs et extérieurs.

- Installation avec boîtier d'encastrement.
- Optique secondaire au choix.
- Alimentation: 350/500mA
- Câble: 50cm

À CONNECTER EN SÉRIE

*Turned steel recessed AISI 304 spot with POWER LED.
It is suitable as main floor lighting for gardens and architectural facades. It can be installed on indoor or outdoor locations.*

- *Outercasing assembly.*
- *Choice of secondary optic.*
- *Power supply: 350/500mA*
- *Cable: cm. 50*

CONNECT IN SERIES

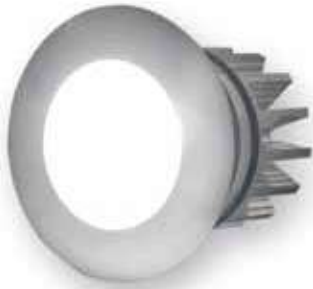
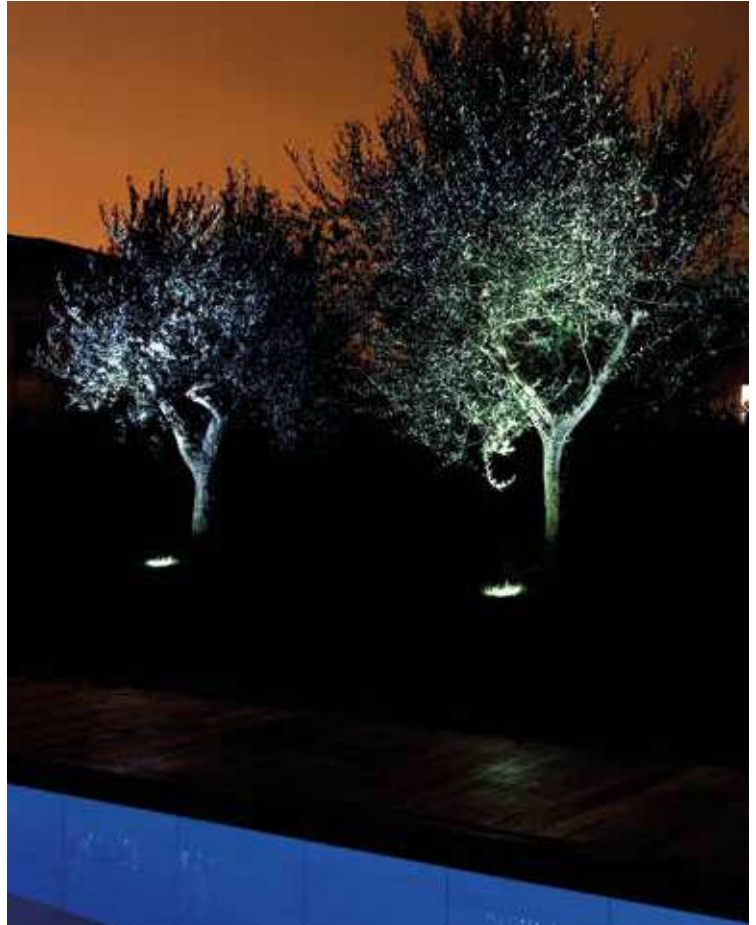

DIMENSIONS / DIMENSIONS

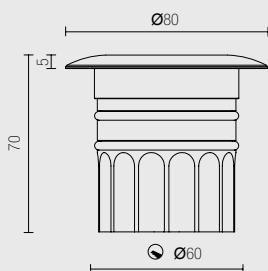

ACCESSOIRES / ACCESSORIES

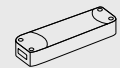
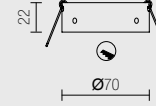
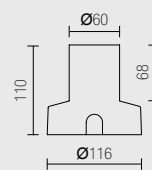

Boîtier d'enc 548/80 p. 296
Outer casing 548/80 page 296

Anneau avec ressorts TES0065
Ring with springs TES0065

Ballasts p. 262-263
Drivers page 262-263

CODES DE BASE / BASE CODES

FAISCEAU LUMINEUX / LIGHT BEAM

VERRE / GLASS

COULEUR LED / LED COLOR

PUISSANCE / POWER

L601.

- 10 10°
- 35 35°
- 60 60°
- 80 80°

- T Transparent / Transparent
- S Sablé / Sandblasted

- BN 4000°K
- BC 3000°K
- CC 2700°K
- BL Bleu / Blue
- VE Vert / Green
- RO Rouge / Red
- AM Ambré / Amber

- 3 4x1W - 350mA - 564 lm
- 5 4x2W 500mA - 704 lm

Exemple de codification : Article ACSO 1 + Faisceau lumineux 40° + Verre transparent + Couleur led 4000°K + Puissance 1W 350mA = Code : L601.40TBN3
Example of codification: Product ACSO 1 + Light beam 40° + Glass transparent + Led color 4000°K + Power 1W 350mA = Code: L601.40TBN3

ACSO 2

L602.

Élément encastrable en acier tourné AISI 304 avec POWER LED et protection contre l'éblouissement. Pour l'éclairage d'accentuation, ou balisage de service au sol ou au mur.

- Pour les espaces intérieurs et extérieurs.
- Installation avec boîtier d'encastrement.
- Diffusion radiale avec polycarbonate opale.
- Alimentation: 350/500mA
- Câble: 50cm

À CONNECTER EN SÉRIE

Turned steel recessed spot AISI 304 with POWER LED and with antiglare protection. It is suitable as accent lighting or as wall or floor service spotlight. It can be installed on indoor or outdoor locations.

- Outercasing assembly.
- Radial diffusion with opal polycarbonate.
- Power supply: 350/500mA
- Cable: cm. 50

CONNECT IN SERIES



ACSO 3

L603.

Élément encastrable en acier tourné AISI 304 avec POWER LED et protection contre l'éblouissement. Pour l'éclairage d'accentuation ou comme balise de service au sol ou au mur.

Pour les espaces intérieurs et extérieurs.

- Installation avec boîtier d'encastrement.
- Optique secondaire asymétrique au choix.
- Alimentation: 350/500mA
- Câble : 50cm

À CONNECTER EN SÉRIE

Turned steel recessed AISI 304 spot with POWER LED and with antiglare protection. It is suitable as accent lighting or as wall or floor service spotlight. It can be installed on indoor or outdoor locations.

- Outercasing assembly.
- Choice of asymmetric secondary optic.
- Power supply: 350/500mA
- Cable: cm. 50

CONNECT IN SERIES



DIMENSIONS / DIMENSIONS

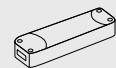
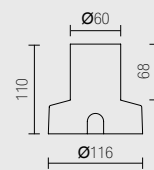
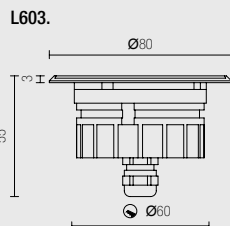
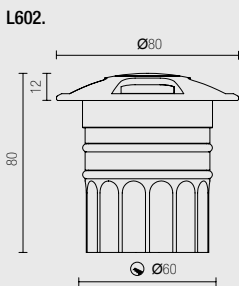

Boîtier d'enc. 548/80 p. 296
Outer casing 548/80 page 296

Ballasts p. 262-263
Drivers page 262-263

CODES DE BASE / BASE CODES

FAISCEAU LUMINEUX / LIGHT BEAM

VERRE / GLASS

COULEUR LED / LED COLOR

PUISSANCE / POWER

L602.

- R4 Radial 4 ouvertures
Radial 4 opening

- BN 4000°K
- BC 3000°K
- CC 2700°K
- BL Bleu / Blue
- VE Vert / Green
- RO Rouge / Red
- AM Ambré / Amber

- 3 4x1W 350mA - 564 lm
- 5 4x2W 500mA - 704 lm

L603.

- 40 40° Asymétrique
Asymmetric
- 80 80° Asymétrique
Asymmetric
- T Transparent / Transparent
- S Sablé / Sandblasted

- 3 1x1W 350mA - 141 lm
- 5 1x2W 500mA - 176 lm

Exemple de codification : Article ACSO 2 + Faisceau lumineux radial 4 ouvertures + Verre transparent + Couleur led 3000°K + Puissance 3x1W 350mA = Code : L602.R4TBC3
Example of codification: Product ACSO 2 + Light beam radial 4 openings + Glass transparent + Led color 3000°K + Power 3X1W 350mA = Code: L602.R4TBC3

ACRUX 1 COB

L701.

Élément encastrable en acier tourné AISI 304 avec LED COB CRI>90.

Pour l'éclairage principal au sol. Pour les jardins et les façades architecturales. Pour les espaces intérieurs et extérieurs.

- Installation avec boîtier d'encastrement.
- Optique secondaire au choix.
- Alimentation: 200mA
- Câble : 50cm

À CONNECTER EN SÉRIE

Turned steel recessed spot AISI 304 with LED COB CRI>90.

It is suitable as main floor lighting for gardens and architectural facades.

It can be installed on indoor or outdoor locations.

- *Outercasing assembly.*
- *Choice of secondary optic.*
- *Power supply: 200mA*
- *Cable: cm. 50*

CONNECT IN SERIES

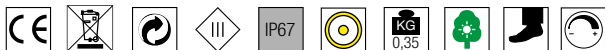

DIMENSIONS / DIMENSIONS

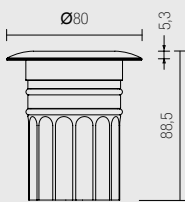

Ø58 sans boîtier d'enc.
Ø58 without outer casing

ACCESSOIRES / ACCESSORIES

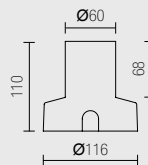

Boîtier d'enc. **548/80** p. 296
Outer Casing 548/80 page 296

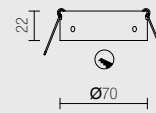

Anneau avec ressorts **TES0065**
Ring with springs TES0065

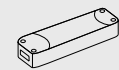

Ballasts (p. 265).
Drivers page 265

CODES DE BASE / BASE CODES

FAISCEAU LUMINEUX / LIGHT BEAM

VERRE / GLASS

COULEUR LED / LED COLOR

PUISSANCE / POWER

L701.

12 12°
24 24°

T Transparent / Transparent
S Sablé / Sandblasted

BN 4000°K
BC 3000°K
CC 2700°K

7W - 200mA - 916 lm CRI>90

Exemple de codification : Article ACRUX 1 + Faisceau lumineux étroit 12° + Verre transparent + Couleur led 4000°K = Code : **L701.10TBN**

Example of codification: Product ACRUX 1 + Light beam narrow 12° + Glass transparent + Led color 4000°K = Code: L701.10TBN

