

POWER SUPPLIES

350mA CONSTANT CURRENT	232
500mA CONSTANT CURRENT	233
CONSTANT CURRENT FOR COB	234
MULTICURRENT	235
CONSTANT VOLTAGE 12Vdc	236
CONSTANT VOLTAGE 24Vdc	237
CONSTANT VOLTAGE 24Vdc DALI2 AND PUSH	239
EMERGENCY DEVICE	241

350mA CONSTANT CURRENT

CODE	DESCRIPTION
AL35004IP	Power supply ON/OFF constant current 350mA 4W IN/OUT cables, IP65 Vin 220-240Vac 1 to 3 LEDs Dimensions mm 38x28x22H

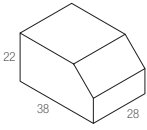

CODE	DESCRIPTION
AL1435IP	Power supply ON/OFF constant current 350mA 14W IN/OUT cables, IP67 Vin 220-240Vac 1 to 12 LEDs Sizes mm 70x38x25H

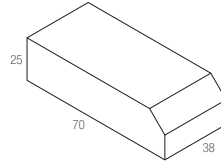

CODE	DESCRIPTION
AL141132	Power supply ON/OFF constant current 350mA 8W Protected screw terminals, IP20 Vin 110-240Vac 1 to 7 LEDs Sizes mm 59x42x22H

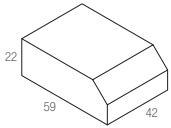

CODE	DESCRIPTION
AL127713	Power supply ON/OFF constant current 350mA 14.5W Protected screw terminals, IP20 Vin 110-240Vac 1 to 12 LEDs Sizes mm 115x34x20H

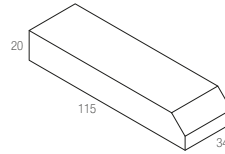

CODE	DESCRIPTION
AL127303	Power supply ON/OFF constant current 350mA 10W Protected screw terminals, IP20 Vin 110-240Vac 1 to 9 LEDs Sizes mm 112x38x22H

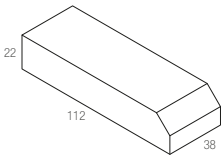

500mA CONSTANT CURRENT

CODE	DESCRIPTION
AL50004IP	Power supply ON/OFF constant current 500mA 4W IN/OUT cables, IP65 Vin 220-240Vac 1 to 2 LEDs Dimensions mm 38x28x22H

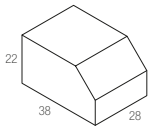

CODE	DESCRIPTION
AL50020IP	Power supply ON/OFF constant current 500mA 17.5W IN/OUT cables, IP67 Vin 110-240Vac 2 to 10 LEDs Sizes mm 118x35x26H

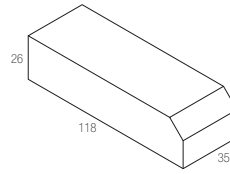

CODE	DESCRIPTION
AL141131	Power supply ON/OFF constant current 500mA 6W Protected screw terminals, IP20 Vin 110-240Vac 1 to 3 LEDs Sizes mm 59x42x22H

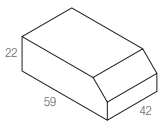

CODE	DESCRIPTION
AL122248	Power supply ON/OFF constant current 500mA 20W Protected screw terminals, IP20 Vin 110-240Vac 1 to 12 LEDs Sizes mm 112x38x27H

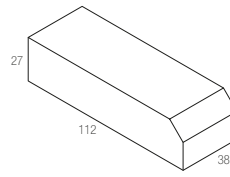

CODE	DESCRIPTION
AL127711	Power supply ON/OFF constant current 500mA 12W Protected screw terminals, IP20 Vin 110-240Vac 1 to 7 LEDs Sizes mm 115x35x20H

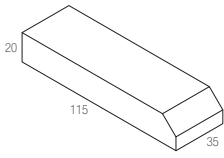

CODE	DESCRIPTION
AL50022IP	Power supply ON/OFF constant current 500mA 22W IN/OUT cables, IP65 Vin 110-240Vac 3 to 10 LEDs Sizes mm 80x73x30H

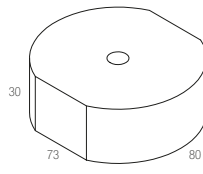

CODE	DESCRIPTION
AL1450IP	Power supply ON/OFF constant current 500mA 14W IN/OUT cables, IP67 Vin 220-240Vac 1 to 7 LEDs Sizes mm 70x38x25H

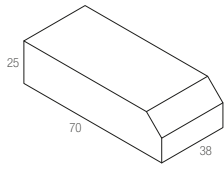

CONSTANT CURRENT FOR COB

CODE	DESCRIPTION
AL20009	Power supply ON/OFF constant current 200mA 9W IN/OUT cables, IP20 Vin 220-240Vac Sizes mm 48x34x24H

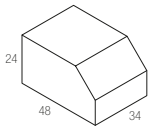

CODE	DESCRIPTION
AL1020IP	Power supply ON/OFF constant current 200mA 8W IN/OUT cables, IP67 Vin 220-240Vac Sizes mm 70x38x25H

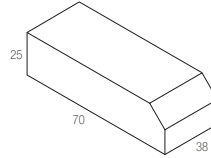

CODE	DESCRIPTION
AL25012	Power supply ON/OFF constant current 250mA 10W Protected pressure terminals, IP20 Vin 220-240Vac Sizes mm 100x38x25H

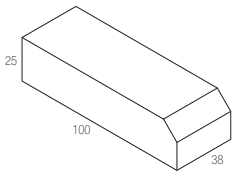

CODE	DESCRIPTION	CONSTANT CURRENT	CONSTANT VOLTAGE
AL45018.MULTI	Multicurrent ON/OFF power supply 200-450mA 18.9W Protected pressure terminals, IP20 Vin 220-240Vac Sizes mm 98x44x30H	200mA 8.4W 240mA - 10.1W 300mA - 12.6W 350mA 14.7W 400mA - 16.8W 450mA 18.9W	24-42Vdc - 18.9W

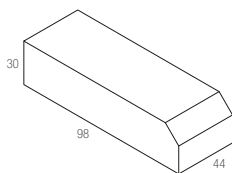

CODE	DESCRIPTION	CONSTANT CURRENT
AL105042.D2	Multicurrent Power Supply DIMMABLE DALI2 and PUSH 150-1050mA 42W Protected pressure terminals, IP20 Vin 220-240Vac Sizes mm 131x43x30H	150mA - 7.8W 200mA - 10.4W 250mA - 13W 300mA - 15.6W 350mA - 18.2W 400mA - 20.8W 500mA - 26W 600mA - 31.2W 700mA - 36.4W 750mA - 39W 800mA - 41.6W 850mA - 41.65W 900mA - 41.4W 950mA - 41.8W 1000mA - 42W

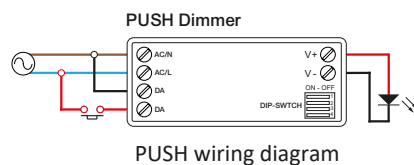
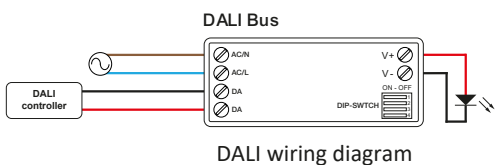
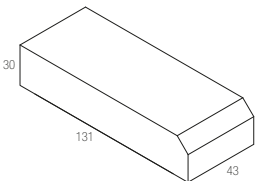

CODE	DESCRIPTION	CONSTANT CURRENT	CONSTANT VOLTAGE
AL122201	Multicurrent ON/OFF power supply 250-700mA 20W Protected pressure terminals, IP20 Vin 220-240Vac Sizes mm 112x52x22H	250mA - 13W min 3 - max 16 LEDs 350mA - 19W min 1 - max 16 LEDs 400mA - 20W min 1 - max 15 LEDs 450mA - 20W min 1 - max 13 LEDs 500mA - 20W min 1 - max 12 LEDs 550mA - 20W min 1 - max 11 LEDs 600mA - 20W min 1 - max 10 LEDs 700mA - 20W min 1 - max 9 LEDs	24Vdc - 16W

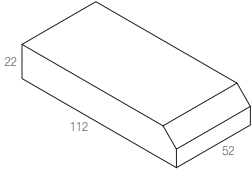

CODE	DESCRIPTION	CONSTANT CURRENT	CONSTANT VOLTAGE
AL125400	Multicurrent Power Supply PUSH DIMMABLE 250-900mA 20W Protected pressure terminals, IP20 Vin 110-240Vac Sizes mm 112x52x22H	250mA - 13W min 6 - max 16 LEDs 300mA - 15W min 6 - max 16 LEDs 350mA - 18W min 4 - max 15 LEDs 400mA - 20W min 4 - max 15 LEDs 450mA - 20W min 1 - max 14 LEDs 500mA - 20W min 1 - max 12 LEDs 550mA - 20W min 1 - max 11 LEDs 600mA - 20W min 1 - max 10 LEDs 650mA - 20W min 1 - max 9 LEDs 700mA - 20W min 1 - max 9 LEDs 750mA - 20W min 1 - max 8 LEDs 800mA - 20W min 1 - max 7 LEDs 850mA - 20W min 1 - max 7 LEDs 900mA - 20W min 1 - max 7 LEDs	12Vdc - 11W 24Vdc - 20W

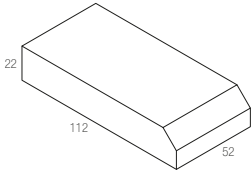

PUSH Dimmer

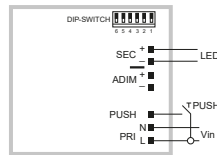

PUSH wiring diagram

CODE	DESCRIPTION	CONSTANT CURRENT
AL70012.D2	Multicurrent Power Supply DIMMABLE DALI2 and PUSH 150-700mA 12W Protected screw terminals, IP20 Vin 220-240Vac Sizes mm 120x30x20H	150mA - 6.3W min 1 - max 13 LEDs 200mA - 8.4W min 1 - max 13 LEDs 250mA - 10.5W min 1 - max 13 LEDs 300mA - 12W min 1 - max 12 LEDs 350mA - 12W min 1 - max 10 LEDs 500mA - 12W min 1 - max 7 LEDs 600mA - 12W min 1 - max 6 LEDs 700mA - 12W min 1 - max 5 LEDs

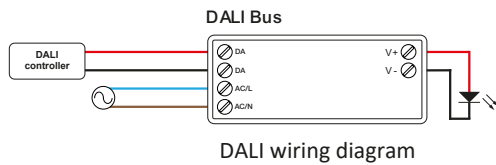
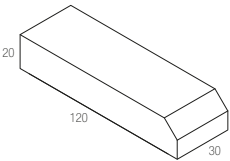

DALI wiring diagram

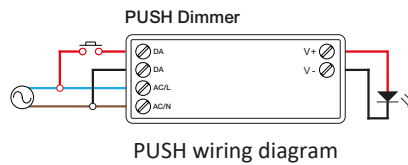

PUSH wiring diagram

CONSTANT VOLTAGE 12Vdc

CODE	DESCRIPTION
AL12004	Constant voltage power supply ON/OFF 12Vdc 4W IN/OUT cables, IP65 Vin 220-240Vac Dimensions mm 38x28x21H

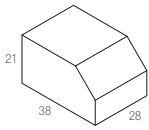

CODE	DESCRIPTION
AL12075	Constant voltage power supply ON/OFF 12Vdc 75W Protected screw terminals, IP20 Vin 220-240Vac Sizes mm 184x61x32H

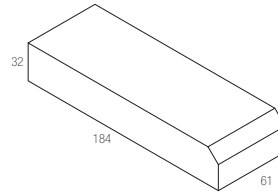

CODE	DESCRIPTION
AL12015	Constant voltage power supply ON/OFF 12Vdc 15W Protected screw terminals, IP20 Vin 220-240Vac Sizes mm 103x36x16H

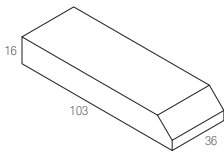

CODE	DESCRIPTION
AL12100	Constant voltage power supply ON/OFF 12Vdc 100W Protected screw terminals, IP20 Vin 110-240Vac Sizes mm 184x61x32H

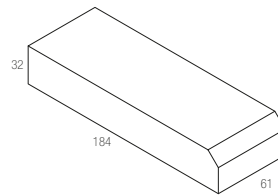

CODE	DESCRIPTION
AL12020	Constant voltage power supply ON/OFF 12Vdc 20W Protected pressure terminals, IP20 Vin 220-240Vac Sizes mm 103x36x16H

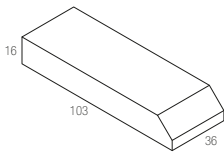

CODE	DESCRIPTION
AL12100IP	Constant voltage power supply ON/OFF 12Vdc 100W IN/OUT cables, IP67 Vin 110-240Vac Sizes mm 190x52x37H

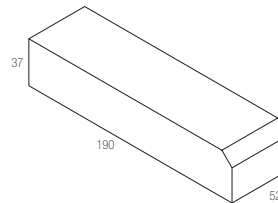

CODE	DESCRIPTION
AL12030B	Constant voltage power supply ON/OFF 12Vdc 30W Protected pressure terminals, IP20 Vin 220-240Vac Sizes mm 155x53x16H

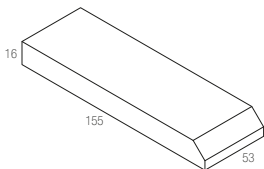

CODE	DESCRIPTION
AL12150	Constant voltage power supply ON/OFF 12Vdc 150W Protected screw terminals, IP20 Vin 220-240Vac Sizes mm 210x67x34H

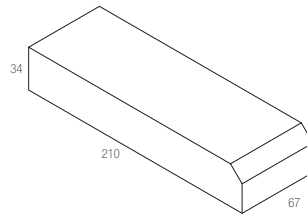

CODE	DESCRIPTION
AL12035IP	Constant voltage power supply ON/OFF 12Vdc 36W IN/OUT cables, IP67 Vin 110-240Vac Sizes mm 150x40x30H

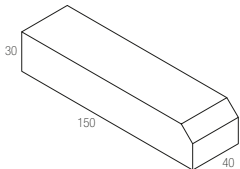

CODE	DESCRIPTION
AL12050	Constant voltage power supply ON/OFF 12Vdc 50W Protected screw terminals, IP20 Vin 110-240Vac Sizes mm 185x64x22H

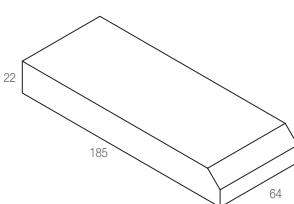

CODE	DESCRIPTION
AL24015	Constant voltage power supply ON/OFF 24Vdc 15W Protected pressure terminals, IP20 Vin 220-240Vac Sizes mm 103x36x16H

CODE	DESCRIPTION
AL24060IP	Constant voltage power supply ON/OFF 24Vdc 60W IN/OUT cables, IP67 Vin 110-240Vac Sizes mm 162x43x32H

CODE	DESCRIPTION
AL24020	Constant voltage power supply ON/OFF 24Vdc 20W Protected pressure terminals, IP20 Vin 220-240Vac Sizes mm 103x36x16H

CODE	DESCRIPTION
AL24060S	Constant voltage power supply ON/OFF 24Vdc 60W Protected screw terminals, IP20 Vin 220-240Vac Sizes mm 305x30x18H

CODE	DESCRIPTION
AL24030B	Constant voltage power supply ON/OFF 24Vdc 30W Protected screw terminals, IP20 Vin 220-240Vac Sizes mm 155x53x16H

CODE	DESCRIPTION
AL24075	Constant voltage power supply ON/OFF 24Vdc 75W Protected screw terminals, IP20 Vin 220-240Vac Sizes mm 184x61x32H

CODE	DESCRIPTION
AL24035IP	Constant voltage power supply ON/OFF 24Vdc 35W IN/OUT cables, IP67 Vin 110-240Vac Sizes mm 150x40x30H

CODE	DESCRIPTION
AL24075S	Constant voltage power supply ON/OFF 24Vdc 75W Protected screw terminals, IP20 Vin 220-240Vac Sizes mm 305x30x18H

CODE	DESCRIPTION
AL24050B	Constant voltage power supply ON/OFF 24Vdc 50W Protected screw terminals, IP20 Vin 110-240Vac Sizes mm 185x64x22H

CODE	DESCRIPTION
AL24075X	Constant voltage power supply ON/OFF 24Vdc 75W Protected pressure terminals, IP20 Vin 220-240Vac Sizes mm 168x38x30H

CODE	DESCRIPTION
AL24060	Constant voltage power supply ON/OFF 24Vdc 60W Protected screw terminals, IP20 Vin 220-240Vac Sizes mm 160x58x18H

CODE	DESCRIPTION
AL24100	Constant voltage power supply ON/OFF 24Vdc 100W Protected screw terminals, IP20 Vin 110-240Vac Sizes mm 184x61x32H

CONSTANT VOLTAGE 24Vdc

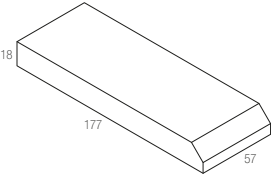
CODE	DESCRIPTION
AL24100B	Constant voltage power supply ON/OFF 24Vdc 100W Protected screw terminals, IP20 Vin 220-240Vac Sizes mm 177x57x18H
	

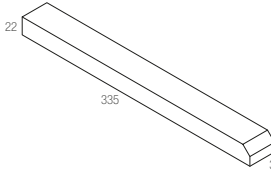
CODE	DESCRIPTION
AL24150S	Constant voltage power supply ON/OFF 24Vdc 150W Protected screw terminals, IP20 Vin 220-240Vac Sizes mm 335x30x22H
	

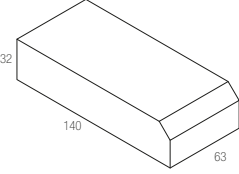
CODE	DESCRIPTION
AL24100IP	Constant voltage power supply ON/OFF 24Vdc 100W IN/OUT cables, IP67 Vin 110-240Vac Sizes mm 140x63x32H
	

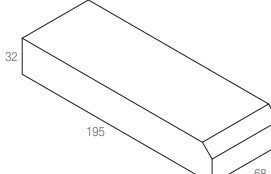
CODE	DESCRIPTION
AL24200	Constant voltage power supply ON/OFF 24Vdc 200W Protected screw terminals, IP20 Vin 220-240Vac Sizes mm 195x68x32H
	

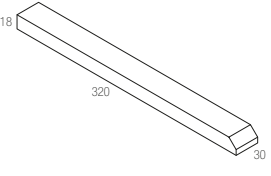
CODE	DESCRIPTION
AL24100S	Constant voltage power supply ON/OFF 24Vdc 100W Protected screw terminals, IP20 Vin 220-240Vac Sizes mm 320x30x18H
	

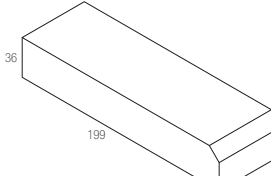
CODE	DESCRIPTION
AL24200IP	Constant voltage power supply ON/OFF 24Vdc 200W IN/OUT cables, IP67 Vin 110-240Vac Sizes mm 199x63x36H
	

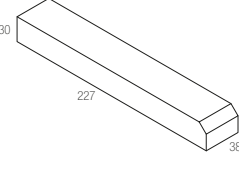
CODE	DESCRIPTION
AL24120	Constant voltage power supply ON/OFF 24Vdc 120W Protected pressure terminals, IP20 Vin 220-240Vac Sizes mm 227x38x30H
	

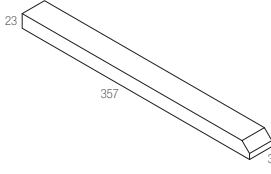
CODE	DESCRIPTION
AL24240S	Constant voltage power supply ON/OFF 24Vdc 240W Protected screw terminals, IP20 Vin 220-240Vac Sizes mm 357x32x23H
	

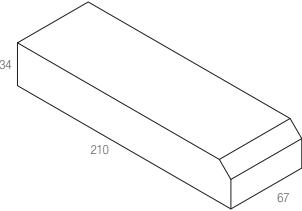
CODE	DESCRIPTION
AL24150	Constant voltage power supply ON/OFF 24Vdc 150W Protected screw terminals, IP20 Vin 220-240Vac Sizes mm 210x67x34H
	

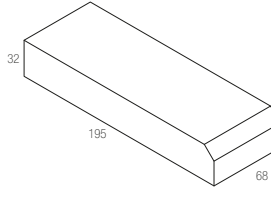
CODE	DESCRIPTION
AL24250	Constant voltage power supply ON/OFF 24Vdc 250W Protected screw terminals, IP20 Vin 220-240Vac Sizes mm 195x68x32H
	

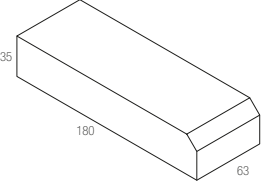
CODE	DESCRIPTION
AL24150IP	Constant voltage power supply ON/OFF 24Vdc 150W IN/OUT cables, IP67 Vin 110-240Vac Sizes mm 180x63x35H
	

CONSTANT VOLTAGE 24Vdc DALI2 AND PUSH

CODE	DESCRIPTION	CONSTANT VOLTAGE
------	-------------	------------------

AL24045.D2

DIMMABLE power supply
DALI2 and PUSH
Protected pressure terminals, IP20
Vin 220-240Vac
Sizes mm 187x45x31H

24Vdc - 45W

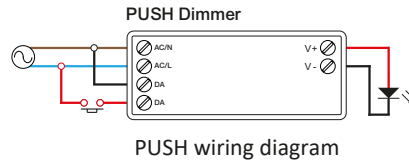
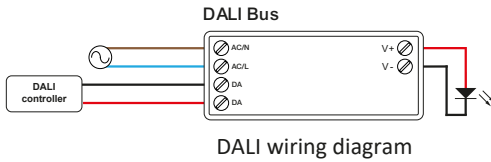
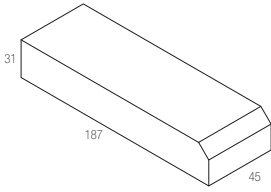

CODE	DESCRIPTION	CONSTANT VOLTAGE
------	-------------	------------------

AL24060.SD2

DIMMABLE power supply
DALI2 and PUSH
Protected pressure terminals, IP20
Vin 220-240Vac
Sizes mm 362x30x21H

24Vdc - 60W

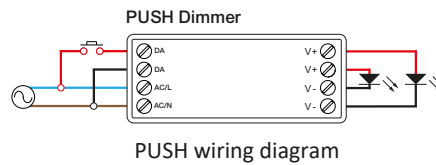
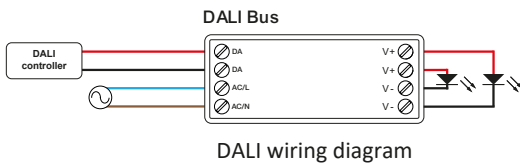
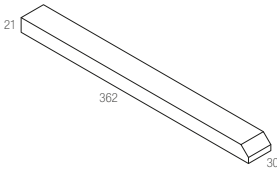

CODE	DESCRIPTION	CONSTANT VOLTAGE
------	-------------	------------------

AL24080.D2

DIMMABLE power supply
DALI2 and PUSH
Protected pressure terminals, IP20
Vin 220-240Vac
Sizes mm 290x45x31H

24Vdc - 80W

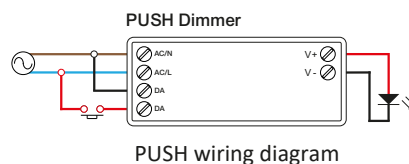
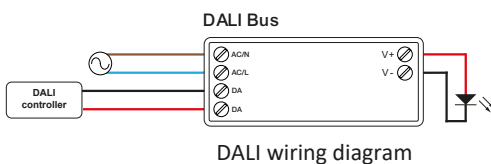
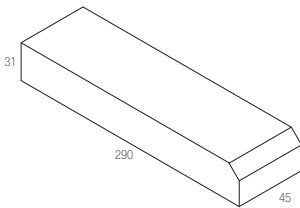

CONSTANT VOLTAGE 24Vdc DALI2 AND PUSH

CODE	DESCRIPTION	CONSTANT VOLTAGE
------	-------------	------------------

AL24150.D2

DIMMABLE power supply
DALI2 and PUSH
Protected pressure terminals, IP20
Vin 220-240Vac
Sizes mm 290x45x31H

24Vdc - 150W

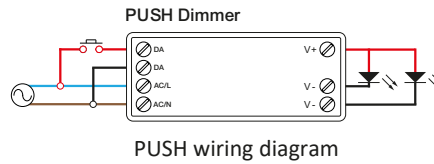
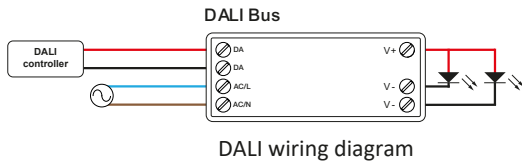
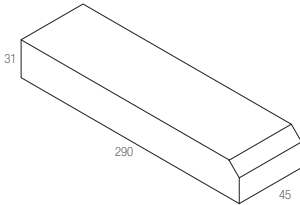

CODE	DESCRIPTION	CONSTANT VOLTAGE
------	-------------	------------------

AL24150.SD2

DIMMABLE power supply
DALI2 and PUSH
Protected pressure terminals, IP20
Vin 220-240Vac
Sizes mm 337x30x18H

24Vdc - 150W

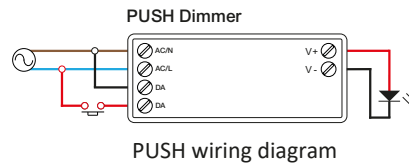
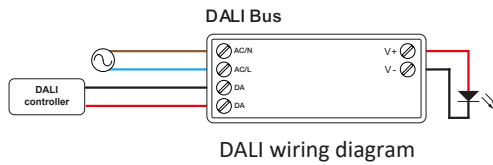
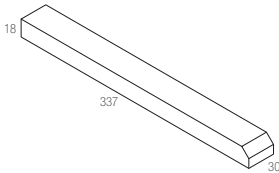

EMERGENCY DEVICES

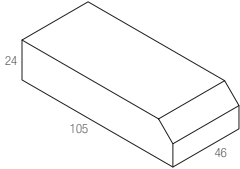
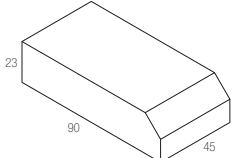
CODE	DESCRIPTION	CONSTANT CURRENT	CONSTANT VOLTAGE
L1241	Emergency lighting power supply with instant switch on if mains power fails. The device has combined operation for both continuous and emergency lighting. Suitable for power LEDs (max. 4W) or LED modules (12Vdc). Measurements of Power Supply mm 105x46x24H Measurements of Battery mm 90x45x23H	1W 350mA 4h autonomy 2W 350mA 3h autonomy 3W 350mA 2h autonomy	12Vdc - 3.6W 1h autonomy 12Vdc - 1.8W 2h autonomy 12Vdc - 1.2W 3h autonomy
Power supply			
Battery			

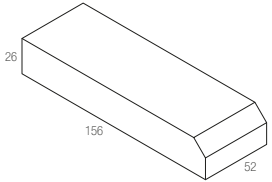
CODE	DESCRIPTION	DIP-SWITCH POSITION A	DIP-SWITCH POSITION B
EL6171	Emergency lighting only power supply with instant switch on if mains power fails. The device only operates continuously when combined with dimmable power controls. DIP-SWITCH adjustable version, for 350mA power LEDs or 12Vdc-24Vdc LED modules. Battery life 1h. Measurements of Power Supply mm 156x52x26H Measurements of Battery mm 135x45x23H	12Vdc - 24W 350mA	24Vdc - 48W 350mA
Power supply			
Battery	