

SUSPENSION ACCESSORIES



BASIC CODES

PD.TCE01.

Suspension mounting KIT with Ø1.2mm 3000mm rope. With the KIT, you can adjust the lamp distance from the ceiling.

FINISHES

■ 6 Chrome

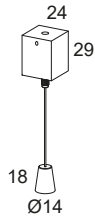

BASIC CODES

PD.TCE02.

Suspension mounting KIT with Ø1.2mm 3000mm rope. With the KIT, you can adjust the lamp distance from the ceiling.

FINISHES

- 1 White
- 2 Matt black
- 7 Brushed aluminium

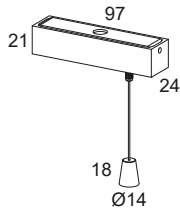

BASIC CODES

PD.TCE03.

Suspension mounting KIT with Ø1.2mm 3000mm rope. With the KIT, you can adjust the lamp distance from the ceiling.

FINISHES

- 1 White
- 2 Matt black
- 7 Brushed aluminium

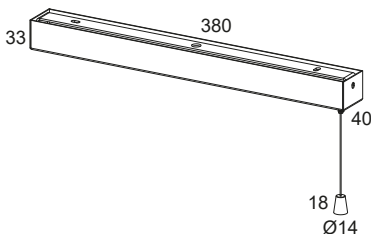

BASIC CODES

PD.TCE06.

Suspension mounting KIT with Ø1.2mm 3000mm rope. With the KIT, you can adjust the lamp distance from the ceiling and house an power supply inside it.

FINISHES

- 1 White
- 2 Matt black
- 7 Brushed aluminium

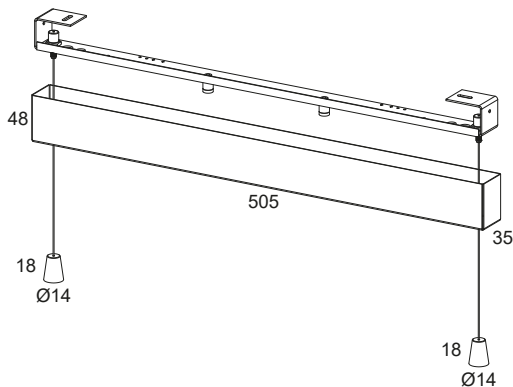

BASIC CODES

PD.TCE07.

Suspension mounting KIT with magnet and Ø1.2mm 3000mm rope. With the KIT, you can adjust the lamp distance from the ceiling and house an power supply inside it.

FINISHES

- 1 White
- 2 Matt black
- 7 Brushed aluminium

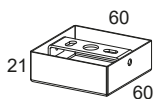

BASIC CODES

SK04.

Off-centred installation accessory. It allows housing the cables inside it, and it can be placed where needed.

FINISHES

- 1 White
- 2 Matt black
- 7 Brushed aluminium

JUNCTION BRACKETS

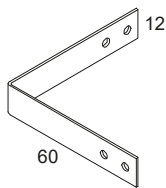

BASIC CODES

STA203

External steel bracket to create a vertical L-shaped fitting. M3x4 set-screws supplied.
Compatible with DELTA, RASO, RHO, YPSILON and TAU profiles.

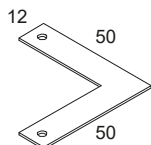

BASIC CODES

STA204

External steel bracket for fixing two 45°cut profiles. M3x4 set-screws supplied.
Compatible with DELTA, RASO, RHO, YPSILON and TAU profiles.

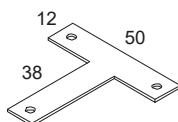

BASIC CODES

STA205

External steel bracket to create a T-shaped fitting. In this configuration, some material is removed from the profiles, to achieve an impeccable visual effect. M3x4 set-screws supplied.
Compatible with DELTA, RASO, RHO, YPSILON and TAU profiles.

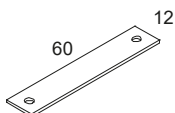

BASIC CODES

STA208

External steel bracket for fixing two in-line profiles. M3x4 set-screws supplied.
Compatible with DELTA, RASO, RHO, YPSILON and TAU profiles.

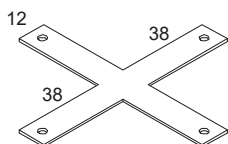

BASIC CODES

STA209

External steel bracket to create an X-shaped fitting. In this configuration, some material is removed from the profiles, to achieve an impeccable visual effect. M3x4 set-screws supplied.
Compatible with DELTA, RASO, RHO, YPSILON and TAU profiles.

MAGNETIC AND DOUBLE-SIDED TAPE



BASIC CODES

NM.

WIDTH

L10 10mm
L15. 15mm
L20 20mm

Magnetic adhesive tape for anodised aluminium profiles. Supplied on a 10-metre reel, 1.2mm thickness.
(Force of attraction >40g/cm².)

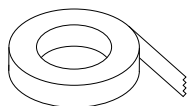

BASIC CODES

4965.

WIDTH

08 8mm
16 16mm

Double-sided adhesive tape for aluminium profiles and LED strips. Supplied on a 50-metre reel.