



**PROFILE TECHNICAL
CATALOGUE 2024**



NANOLED LIGHTING is the lighting brand of Tecnocavi Service, an Italian company founded in 1994.

In the **NANOLED LIGHTING Profiled Technical Catalogue 2024**, it offers a wide range of aluminium profiles designed for LED light sources. All matrices are the company's exclusive property, and the EN AW-6060 alloy extrusion is executed only in Italy, at historical and reliable partner sites. The wide range of products is complemented by many accessories to design and build the perfect architecture and interior design solutions. NANOLED LIGHTING provides its customers and employees a wide range of readily-available items, and all the services necessary, such as bespoke cuts, including slanted cuts.

NANOLED LIGHTING provides and accompanies its partners with all the photometric, technical and commercial support needed to integrate its products into a wide variety of projects. The company system and production process are certified by European certification body CSQ-IQNET, which periodically assesses that all procedures and quality control processes adopted comply with Certification ISO9001:2015



TABLE OF CONTENTS

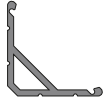

BETA

PAGE 10



C1

PAGE 12



C2

PAGE 14

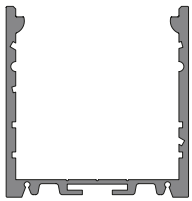

DELTA

PAGE 16

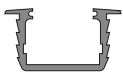

EPTA

PAGE 18



GAMMA

PAGE 22



H1

PAGE 24



H2

PAGE 26

TABLE OF CONTENTS





	H3	PAGE 28
	IOTA	PAGE 30
	JEY	PAGE 32
	KAPPA	PAGE 36
	MILKY	PAGE 40
	MINI	PAGE 42
	OMEGA	PAGE 44
	QU	PAGE 48

TABLE OF CONTENTS

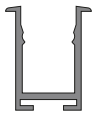
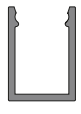
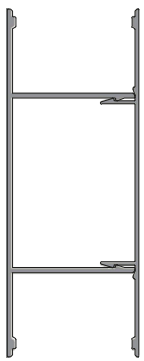

RASO

PAGE 50

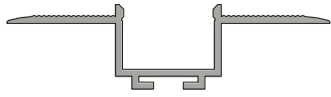

REFLEX

PAGE 52

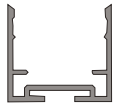

RHO

PAGE 54



SIGMA

PAGE 56

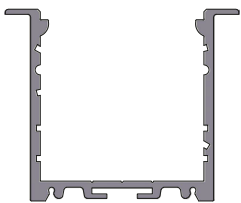

TAU

PAGE 58



VEGA

PAGE 60



VELA

PAGE 62

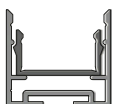

YPSILON

PAGE 66

TABLE OF CONTENTS



ZETA

PAGE 70

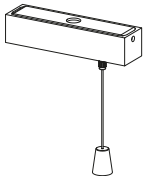

SUSPENSION ACCESSORIES

PAGE 74

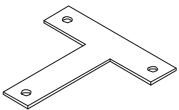

JUNCTION BRACKETS

PAGE 75



MAGNETIC ADHESIVE TAPE

PAGE 76

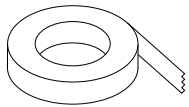

DOUBLE-SIDED TAPE

PAGE 76



BETA

Anodized aluminium 6060 extruded profile with 45° light output, compatible with surface mounting on flat surfaces. Extremely easy to install, thanks to the fixing clips, the snap-in diffuser, and the flush-mounted side supports. Required for the correct dissipation of LED strips, and recommended for panel, under-wall cupboard, shelf and display case lighting.

 EXTRUDED IN ITALY

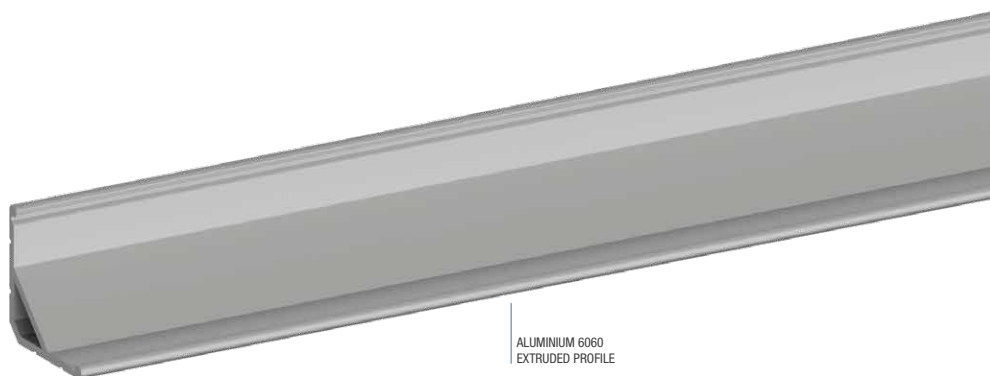

1:1 SCALE

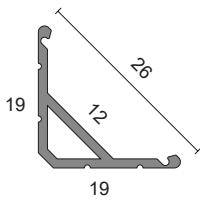

BASIC CODES

PA.BETA.

LENGTH

- 1 1000mm
- 2 2000mm
- 3 3000mm

FINISHES

- 1 Matt white RAL9003
- 2 Matt black RAL9005
- 7 Brushed aluminium

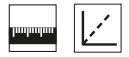

1.2

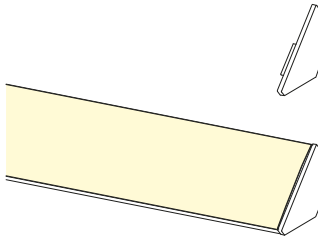

BASIC CODES

SB01.

FINISHES

- 1 White
- 2 Matt black
- 5 Grey
- 7 Brushed aluminium

Side ABS closing support. Easy and quick to install, by exerting a slight side pressure.

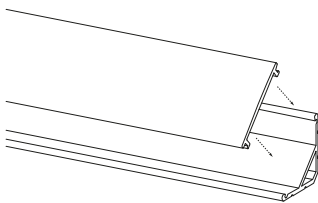

BASIC CODES

PA.26PE04.

LENGTH

- 1 1000mm brushed
- 2 2000mm brushed
- 3 3000mm brushed

Brushed snap-on diffuser. The diffuser can be easily removed for maintenance operations.

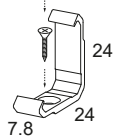
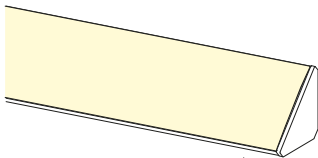

BASIC CODES

SB02.8

Transparent polycarbonate clip with 12xM2.5 screw for surface mounting.

NB. We recommend No. 1 Clip per 500mm

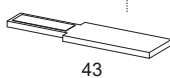
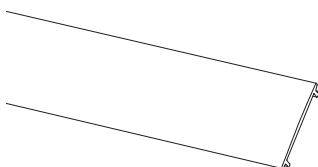

BASIC CODES

TC02

Rectangular electronic device with ON/OFF TOUCH system. The LED can be switched ON/OFF by gently touching the sensitive device section. To be installed inside the profile, in contact with the diffuser, with the double-sided tape supplied (12Vdc and 24Vdc 4A max.)

Code example: BETA Profile + 1000mm Length + Brushed Aluminium Finish = Code: PA.BETA.17

C1

Small-size anodized aluminium 6060 extruded profile, ideal to be flush-mounted even on thin surfaces or surface mounting on flat surfaces. Extremely easy to install, thanks to the snap-in diffuser, and the flush-mounted side supports. Required for the correct dissipation of LED strips, and recommended for alcove, under-wall cupboard, shelf and display case lighting.

 EXTRUDED IN ITALY

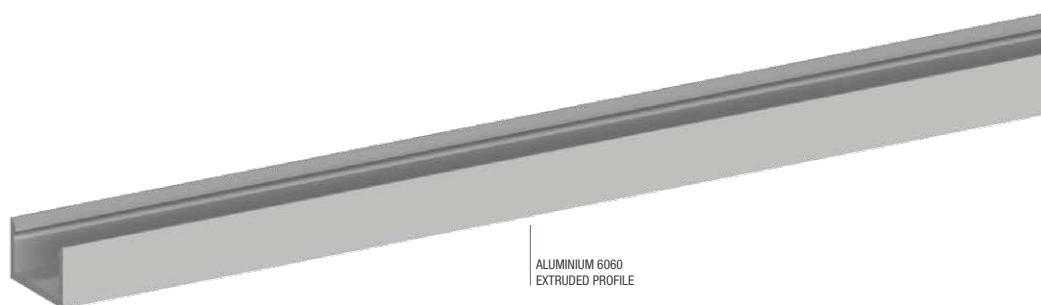

1:1 SCALE

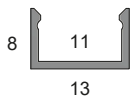

BASIC CODES

PA.C1.

LENGTH

- 1 1000mm
- 2 2000mm
- 3 3000mm

FINISHES

- 1 Matt white RAL9003
- 2 Matt black RAL9005
- 7 Brushed aluminium

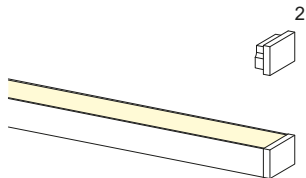
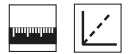

BASIC CODES

SC1.

FINISHES

- 1 White
- 2 Matt black
- 7 Brushed aluminium

Side aluminium closing support. Easy and quick to install, by exerting a slight side pressure.

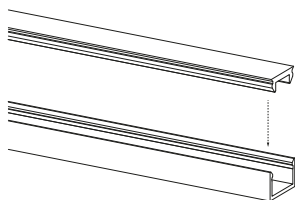

BASIC CODES

PA.13X08.

LENGTH

- 1 1000mm brushed
- 2 2000mm brushed
- 3 3000mm brushed

Brushed snap-on diffuser. The diffuser can be easily removed for maintenance operations.

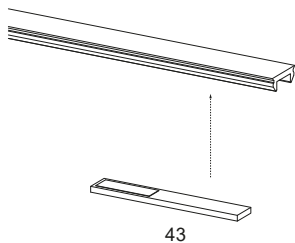

BASIC CODES

TC22

Rectangular electronic device with ON/OFF TOUCH system. The LED can be switched ON/OFF by gently touching the sensitive device section. To be installed inside the profile, in contact with the diffuser, with the double-sided tape supplied (12Vdc and 24Vdc 3A max.)

Code example: C1 Profile + 1000mm Length + Brushed Aluminium Finish = Code: PA.C1.17

C2

Small-size anodized aluminium 6060 extruded profile, ideal to be flush-mounted even on thin surfaces or surface mounting on flat surfaces. Extremely easy to install, thanks to the snap-in diffuser, and the flush-mounted side supports. Required for the correct dissipation of LED strips, and recommended for alcove, under-wall cupboard, shelf and display case lighting.

 EXTRUDED IN ITALY

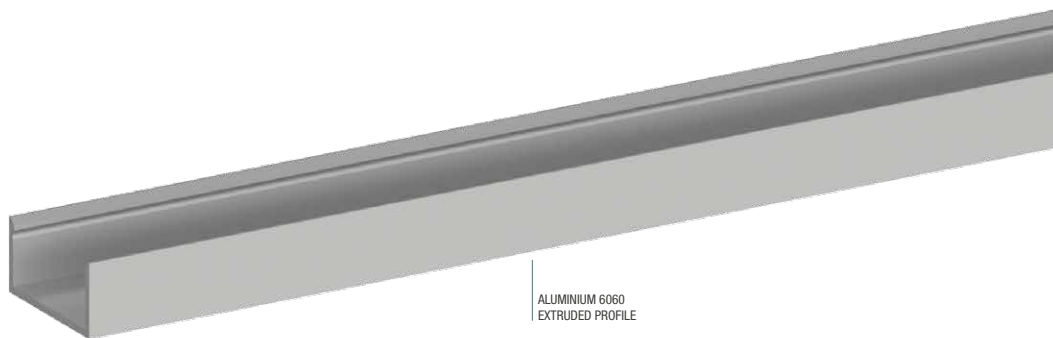

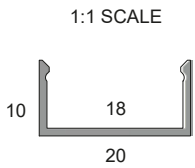

BASIC CODES
PA.C2.

LENGTH
1 1000mm
2 2000mm
3 3000mm

FINISHES
 1 Matt white RAL9003
 2 Matt black RAL9005
 7 Brushed aluminium

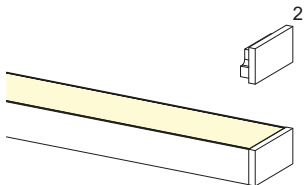

BASIC CODES
SC2.

FINISHES
 1 White
 2 Matt black
 7 Brushed aluminium

Side closing support. Made of aluminium. Easy and quick to install, by exerting a slight side pressure.

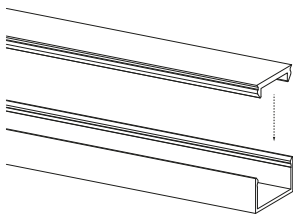

BASIC CODES
PA.20X10.

LENGTH
1 1000mm brushed
2 2000mm brushed
3 3000mm brushed

Brushed snap-on diffuser. The diffuser can be easily removed for maintenance operations.

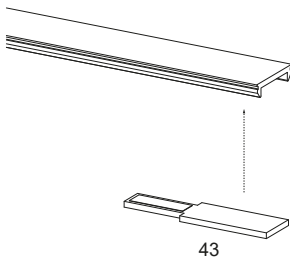

BASIC CODES
TC02

Rectangular electronic device with ON/OFF TOUCH system. The LED can be switched ON/OFF by gently touching the sensitive device section. To be installed inside the profile, in contact with the diffuser, with the double-sided tape supplied (12Vdc and 24Vdc 4A max.)

Code example: C2 Profile + 1000mm Length + Brushed Aluminium Finish = Code: PA.C2.17

DELTA

Anodized aluminium 6060 extruded profile, designed and manufactured to be installed on any surface; thanks to its size, it creates a bold and sophisticated light source. Extremely easy to install, thanks to the brushed snap-in diffuser and side supports. With its range of accessories, it can be mounted on different surfaces or as a suspension lamp. Ideal to house and dissipate LED Strips, including high-density models, and especially suited to illuminate and embellish offices, rooms, hallways, kitchens and much more.

 EXTRUDED IN ITALY

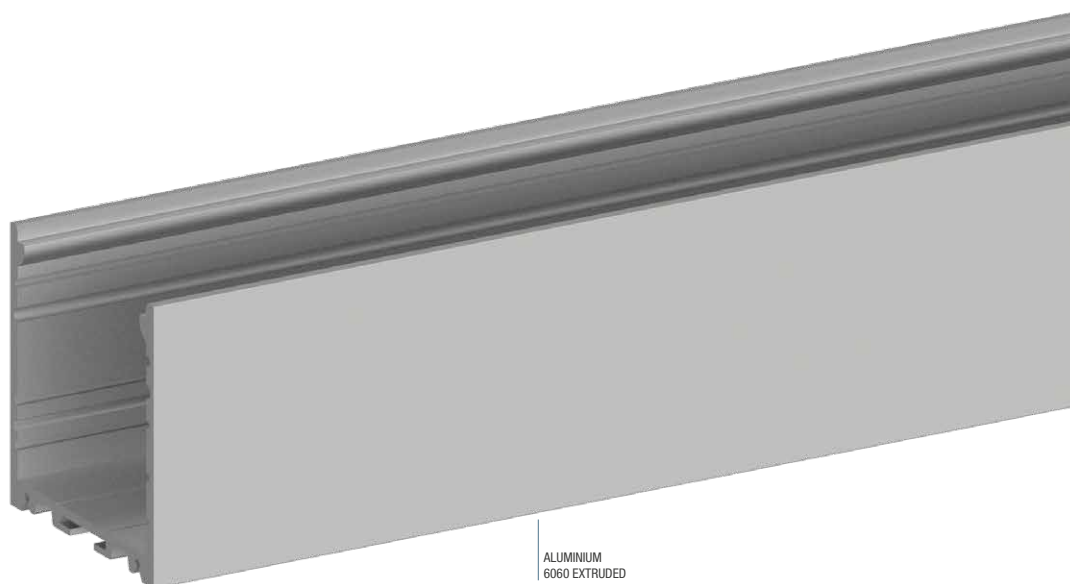

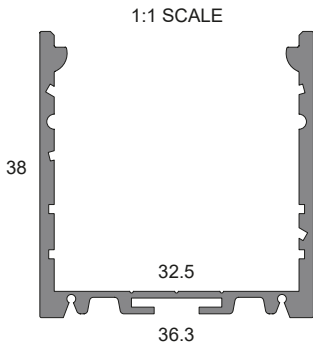

BASIC CODES

PA.DELTA.

LENGTH

- 1 1000mm
- 2 2000mm
- 3 3000mm

FINISHES

- 1 Matt white RAL9003
- 2 Matt black RAL9005
- 7 Brushed aluminium

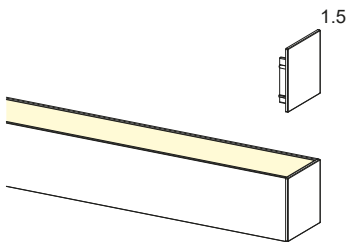
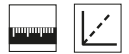

BASIC CODES

SD01.

FINISHES

- 1 White
- 2 Matt black
- 5 Grey
- 7 Brushed aluminium

Side ABS closing support. Easy and quick to install, by exerting a slight side pressure.

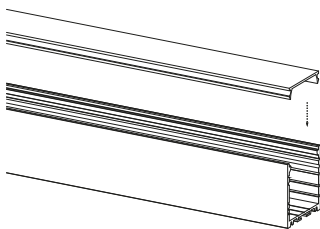

BASIC CODES

PA.PC30PE33.

LENGTH

- 1 1000mm brushed
- 2 2000mm brushed
- 3 3000mm brushed

- 1M 1000mm microprismatic
- 2M 2000mm microprismatic
- 3M 3000mm microprismatic

Brushed or microprismatic snap-on diffuser. The diffuser can be easily removed for maintenance operations.

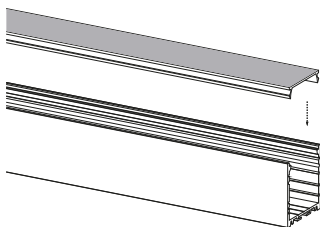

BASIC CODES

PA.2107.

LENGTH

- 1 1000mm
- 2 2000mm
- 3 3000mm

FINISHES

- 1 Matt white RAL9003
- 2 Matt black RAL9005
- 7 Brushed aluminium

Snap-in aluminium cover. The cover can be used to create a lightless zone where the power supply can be installed.

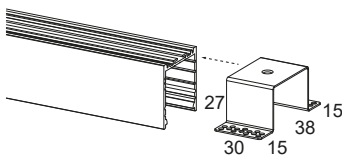

BASIC CODES

SD03

Support for DELTA profile flush-mounting installation. They can be installed on the back of the profile and fixed to the 12mm plasterboard through self-tapping screws.

NB. We recommend No. 1 Support per 500mm

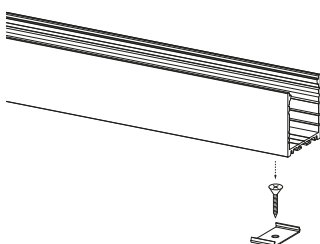

BASIC CODES

PA.GG03

Steel clip for surface-mounting on flat surfaces. The clip hooks onto the rear profile slots, which will be perfectly adhered to the surface. 12xM2.5 screws included.

NB. We recommend No. 1 Support per 500mm

Code example: DELTA Profile + 1000mm Length + Brushed Aluminium Finish = Code: PA.DELTA.17

EPTA

Small-size anodized aluminium 6060 extruded profile, designed and produced to be flush-mounted even on very thin surfaces, such as furniture and kitchen tops. Extreme versatility and adaptability ensured by a wide range of accessories for light control on the profile. Available in several sizes, it is ideal to house and dissipate LED Strips. Especially suited to illuminate and embellish kitchen and bathroom cabinets, under-wall cupboards, furniture, closets, shelves and display cases.

 EXTRUDED IN ITALY

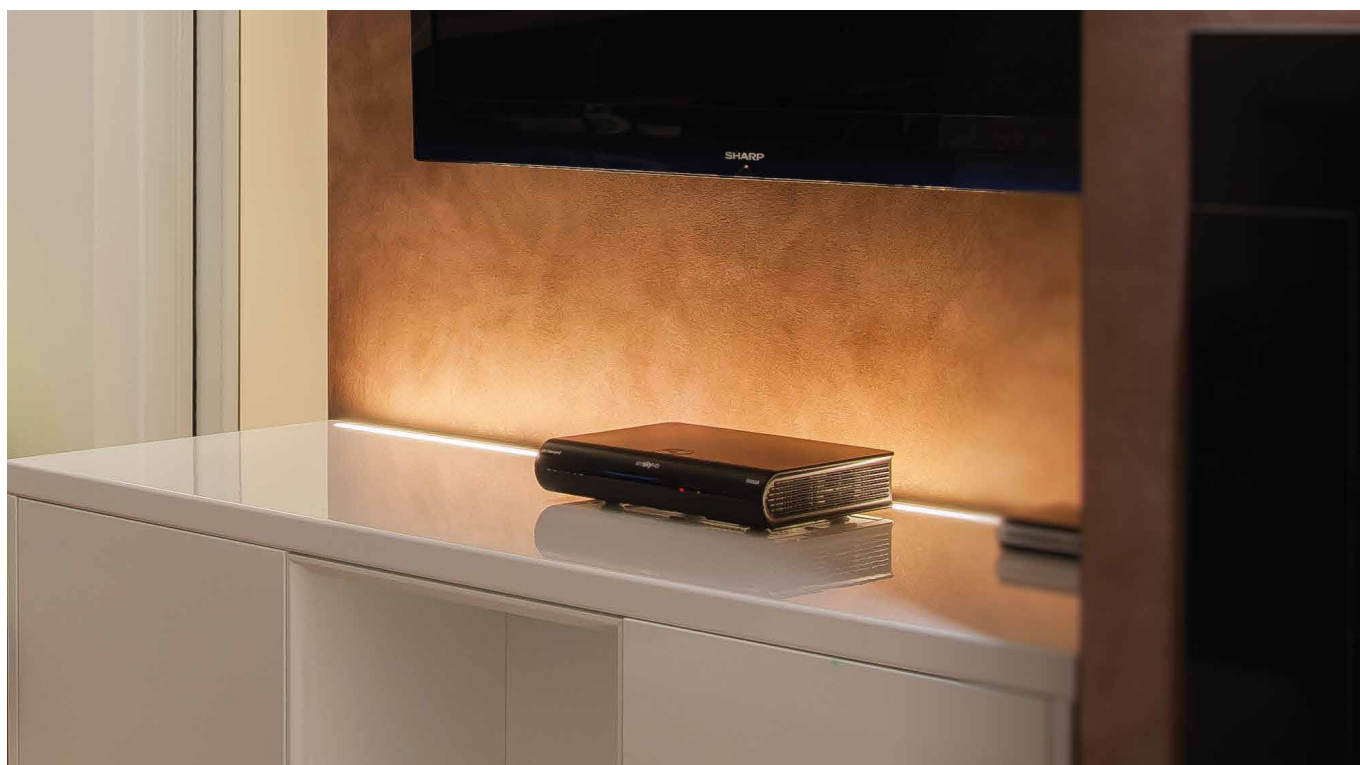

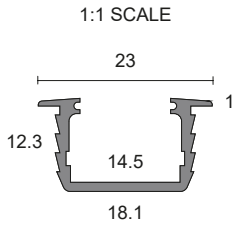

BASIC CODES

PA.EPTA.

LENGTH

- 1 1000mm
- 2 2000mm
- 3 3000mm

FINISHES

- 1 Matt white RAL9003
- 2 Matt black RAL9005
- 7 Brushed aluminium

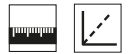

BASIC CODES

SE01.

FINISHES

- 1 White
- 2 Matt black
- 5 Grey
- 7 Brushed aluminium

FUNCTIONS

- C** Closure

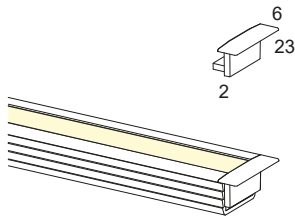

Side closing support and ABS flush-mounting, Easy and quick to install, by exerting a slight side pressure.

BASIC CODES

SE01.

FINISHES

- 1 White
- 2 Matt black
- 5 Grey
- 7 Brushed aluminium

FUNCTIONS

- T** ON/OFF Touch closure

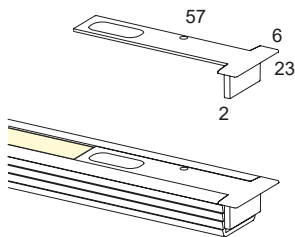

Side closing support and ABS flush-mounting, with ON/OFF Touch device. The LED can be switched ON and OFF with a slight touch. (12Vdc and 24Vdc 4A max.)

BASIC CODES

SE01.

FINISHES

- 1 White
- 2 Matt black
- 5 Grey
- 7 Brushed aluminium

FUNCTIONS

- S** ON/OFF SENSOR closure

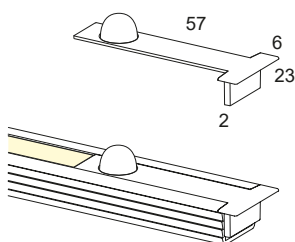

Side closing support and ABS flush-mounting, with ON/OFF Sensor. The Sensor system is motion-activated to switch ON the LED. If no movements are detected, the LED switches OFF. (12Vdc and 24Vdc 4A max.)

BASIC CODES

SE01.

FINISHES

- 1 White
- 2 Matt black
- 5 Grey
- 7 Brushed aluminium

FUNCTIONS

- I** ON/OFF closure

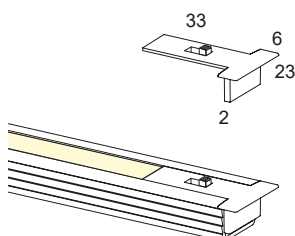

Side closing support and ABS flush-mounting, with ON/OFF switch.

Code example: EPTA Profile + 1000mm Length + Brushed Aluminium Finish = Code: PA.EPTA.17

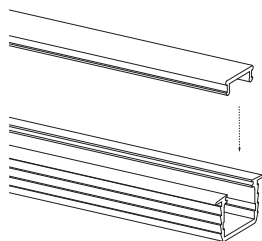

BASIC CODES

PA.07PE81.

LENGTH

- 1** 1000mm brushed
- 2** 2000mm brushed
- 3** 3000mm brushed

Brushed snap-on diffuser. The diffuser can be easily removed for maintenance operations.

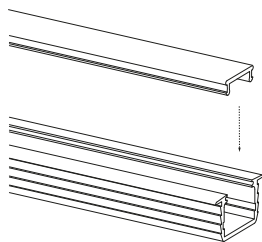

BASIC CODES

PA.07PE81.

LENGTH

- 1T** 1000mm transparent
- 2T** 2000mm transparent
- 3T** 3000mm transparent

Transparent snap-on diffuser. The diffuser can be easily removed for maintenance operations.

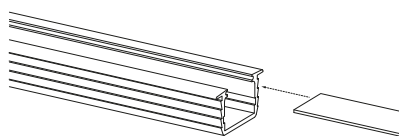

BASIC CODES

PA.02NA12.

LENGTH

- 1** 1000mm brushed
- 2** 2000mm brushed
- 3** 3000mm brushed

Brushed diffuser to insert on the profile internal slots.

Code example: EPTA Profile + 1000mm Length + Brushed Aluminium Finish = Code: PA.EPTA.17



GAMMA

Small-size anodized aluminium 6060 extruded profile, designed and produced to be installed also on very small surfaces. Extremely easy to install, thanks to the brushed snap-in diffuser and side supports. Ideal to house and dissipate LED Strips, and especially suited to illuminate and embellish kitchen and bathroom cabinets and panels, under-wall cupboards, furniture, closets, shelves and display cases.

 EXTRUDED IN ITALY

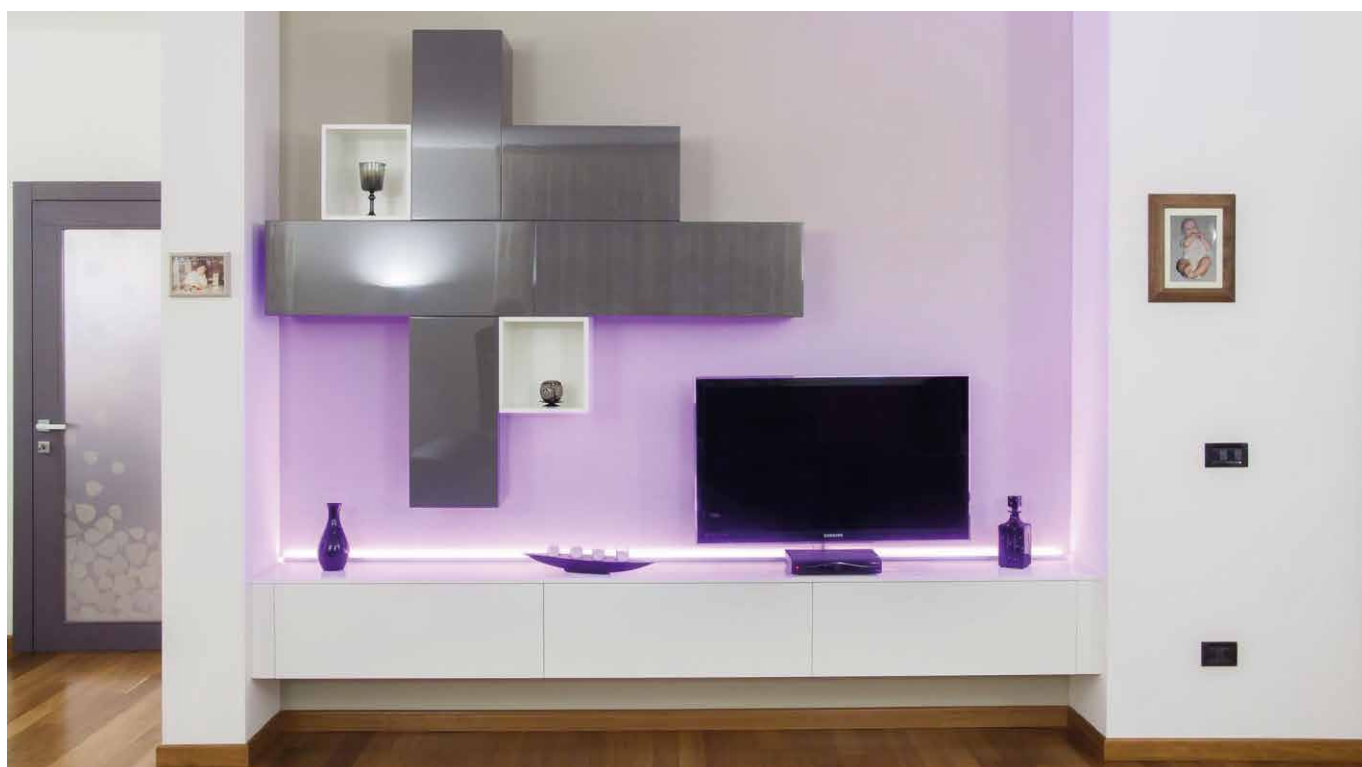

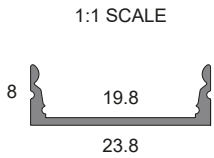

BASIC CODES

PA.GAMMA.

LENGTH

- 1 1000mm
- 2 2000mm
- 3 3000mm

FINISHES

- 1 Matt white RAL9003
- 2 Matt black RAL9005
- 7 Brushed aluminium

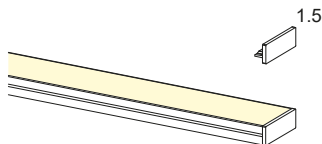
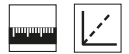

BASIC CODES

SM01.

FINISHES

- 1 White
- 2 Matt black
- 5 Grey
- 7 Brushed aluminium

Side ABS closing support. Easy and quick to install, by exerting a slight side pressure.

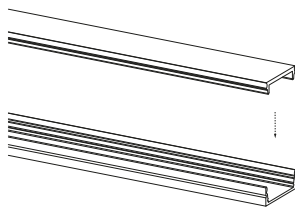

BASIC CODES

PA.13PE49.

LENGTH

- 1 1000mm brushed
- 2 2000mm brushed
- 3 3000mm brushed

Brushed snap-on diffuser. The diffuser can be easily removed for maintenance operations.

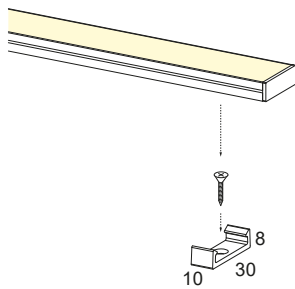

BASIC CODES

SM02.8

Transparent polycarbonate clip with 12xM2.5 screws for mounting on a variety of surfaces.

NB. We recommend No. 1 Clip per 500mm

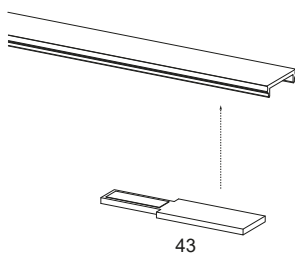

BASIC CODES

TC02

Rectangular electronic device with ON/OFF TOUCH system. The LED can be switched ON/OFF by gently touching the sensitive device section. To be installed inside the profile, in contact with the diffuser, with the double-sided tape supplied (12Vdc and 24Vdc 4A max.)

Code example: GAMMA Profile + 1000mm Length + Brushed Aluminium Finish = Code: PA.GAMMA.17

H1

Small-size anodized aluminium 6060 extruded profile, designed and produced to be installed also on very thin surfaces. Extremely easy to install, thanks to the brushed snap-in diffuser, concealed magnets, and steel springs. Ideal to house and dissipate LED Strips, and especially suited to illuminate and embellish kitchen and bathroom cabinets, under-wall cupboards, furniture, closets, shelves and display cases.

 EXTRUDED IN ITALY

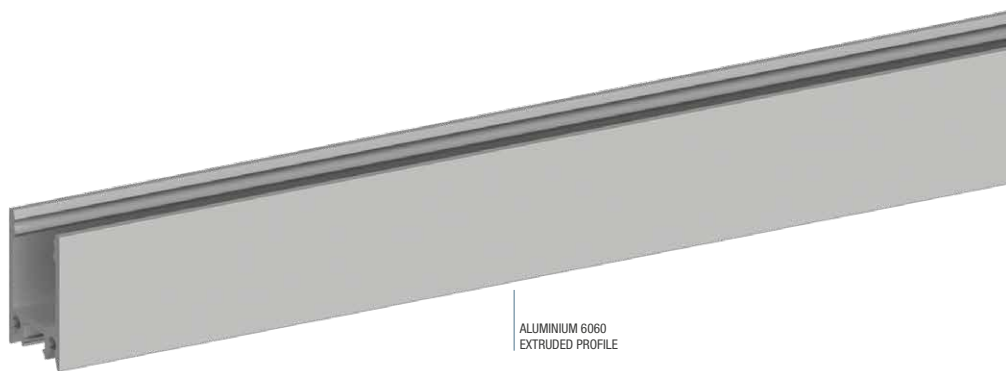

1:1 SCALE

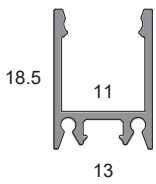

BASIC CODES

PA.H1.

LENGTH

- 1 1000mm
- 2 2000mm
- 3 3000mm

FINISHES

- 1 Matt white RAL9003
- 2 Matt black RAL9005
- 7 Brushed aluminium

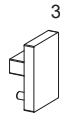
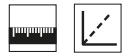

BASIC CODES

SH1.

FINISHES

- 1 White
- 2 Matt black
- 7 Brushed aluminium

Side aluminium closing support. Easy and quick to install, by exerting a slight side pressure.

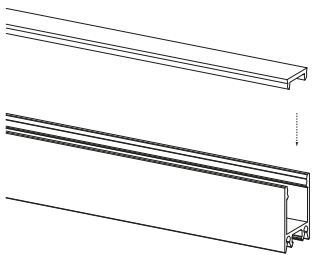
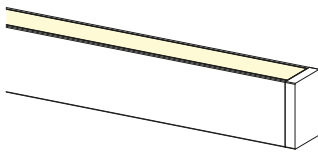

BASIC CODES

PA.12PE41.

LENGTH

- 1 1000mm brushed
- 2 2000mm brushed
- 3 3000mm brushed

Brushed snap-on diffuser. The diffuser can be easily removed for maintenance operations.

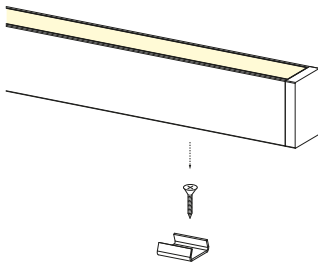

BASIC CODES

PA.GG02

Steel clip for snapping onto flat surfaces. The clip hooks onto the rear slots, which will be perfectly adhered to the surface. 12xM2.5 screws included.

NB. We recommend No. 1 Clip per 500mm

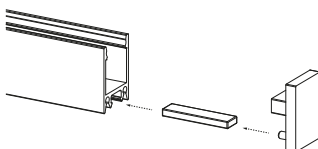

BASIC CODES

NDL40XP5X2

Magnets to glue on for fixing on smooth metal surfaces.

NB. We recommend No. 1 magnet every 150mm (Max. attraction force 1.60kg).

Code example: H1 Profile + 1000mm Length + Brushed Aluminium Finish = Code: PA.H1.17

H2

Small-size anodized aluminium 6060 extruded profile, designed and produced to be installed also on very thin surfaces. Extremely easy to install, thanks to the brushed snap-in diffuser, concealed magnets, and steel springs. Ideal to house and dissipate LED Strips, and especially suited to illuminate and embellish kitchen and bathroom cabinets, under-wall cupboards, furniture, closets, shelves and display cases.

 EXTRUDED IN ITALY

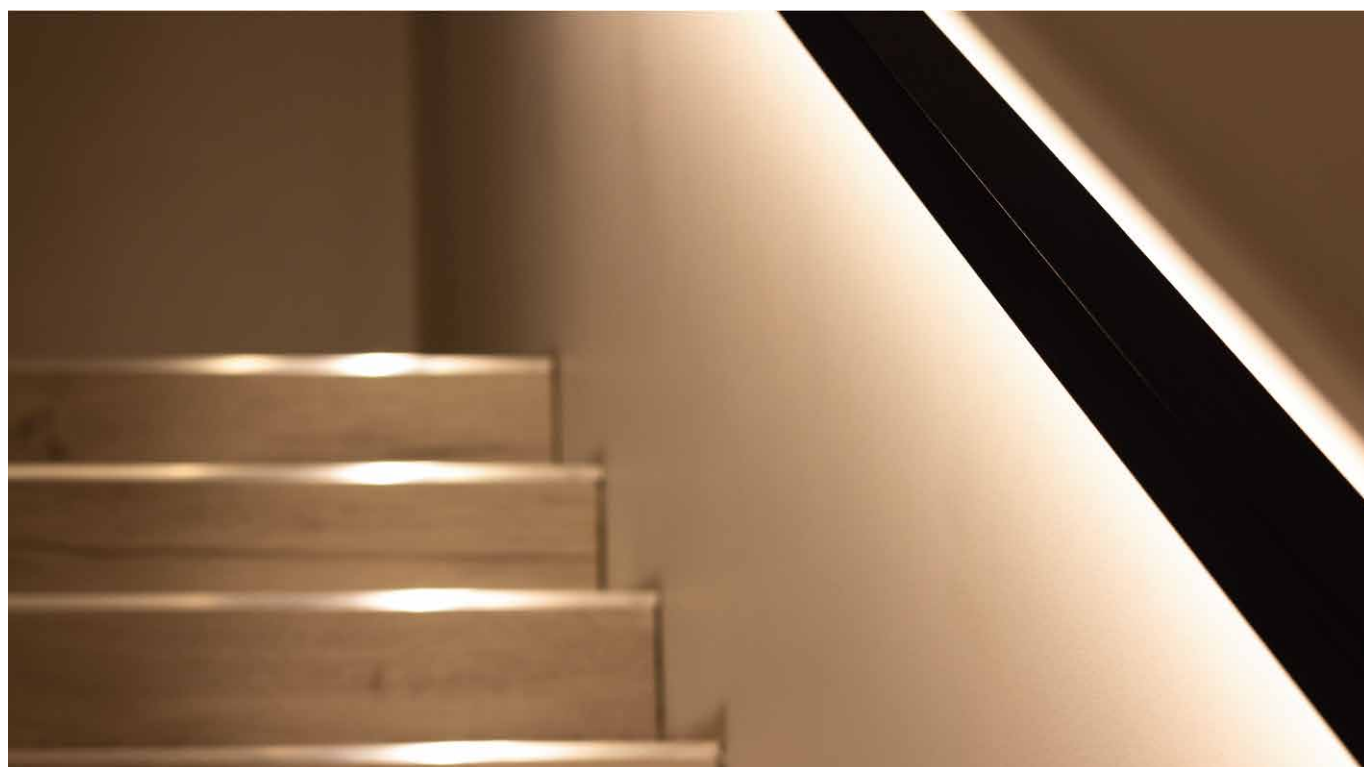
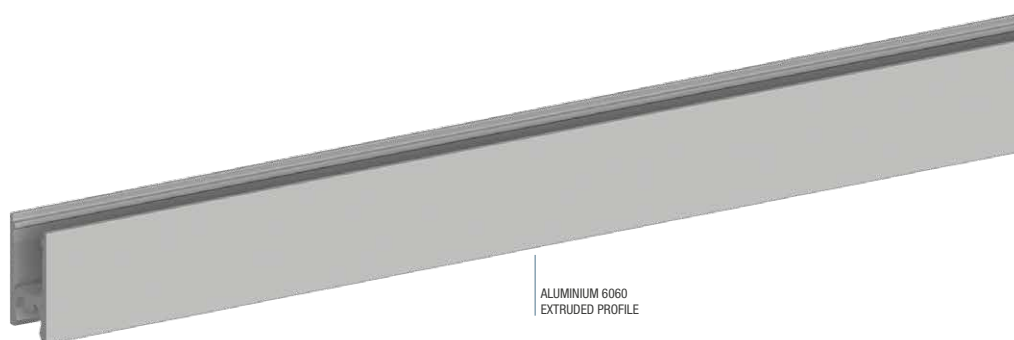

1:1 SCALE

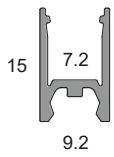

BASIC CODES

PA.H2.

LENGTH

- 1 1000mm
- 2 2000mm
- 3 3000mm

FINISHES

- 1 Matt white RAL9003
- 2 Matt black RAL9005
- 7 Brushed aluminium

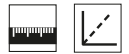

BASIC CODES

SH2.

FINISHES

- 1 White
- 2 Matt black
- 7 Brushed aluminium

Side aluminium closing support. Easy and quick to install, by exerting a slight side pressure.

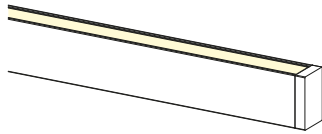

BASIC CODES

PA.PL0720.

LENGTH

- 1 1000mm brushed
- 2 2000mm brushed
- 3 3000mm brushed

Brushed snap-on diffuser. The diffuser can be easily removed for maintenance operations.

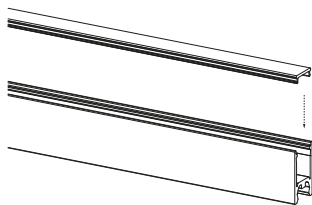

BASIC CODES

PA.GG10

Steel clip for snapping onto flat surfaces. The clip hooks onto the rear slots, which will be perfectly adhered to the surface. 12xM2.5 screws included.

NB. We recommend No. 1 Clip per 500mm

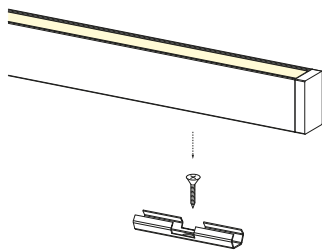

BASIC CODES

NDL12XP6X2

Magnets to glue on for fixing on smooth metal surfaces.

NB. We recommend No. 1 magnet every 150mm (Max. attraction force 0.880kg).

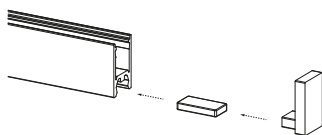

Code example: H2 Profile + 1000mm Length + Brushed Aluminium Finish = Code: PA.H2.17

H3

Extra-small anodized aluminium 6060 extruded profile, designed and produced to be installed also on very thin surfaces. Extremely easy to install, thanks to the brushed snap-in diffuser and concealed magnets. Ideal to house and dissipate LED Strips, and especially suited to illuminate and embellish kitchen and bathroom cabinets, under-wall cupboards, furniture, closets, shelves and display cases.

 EXTRUDED IN ITALY

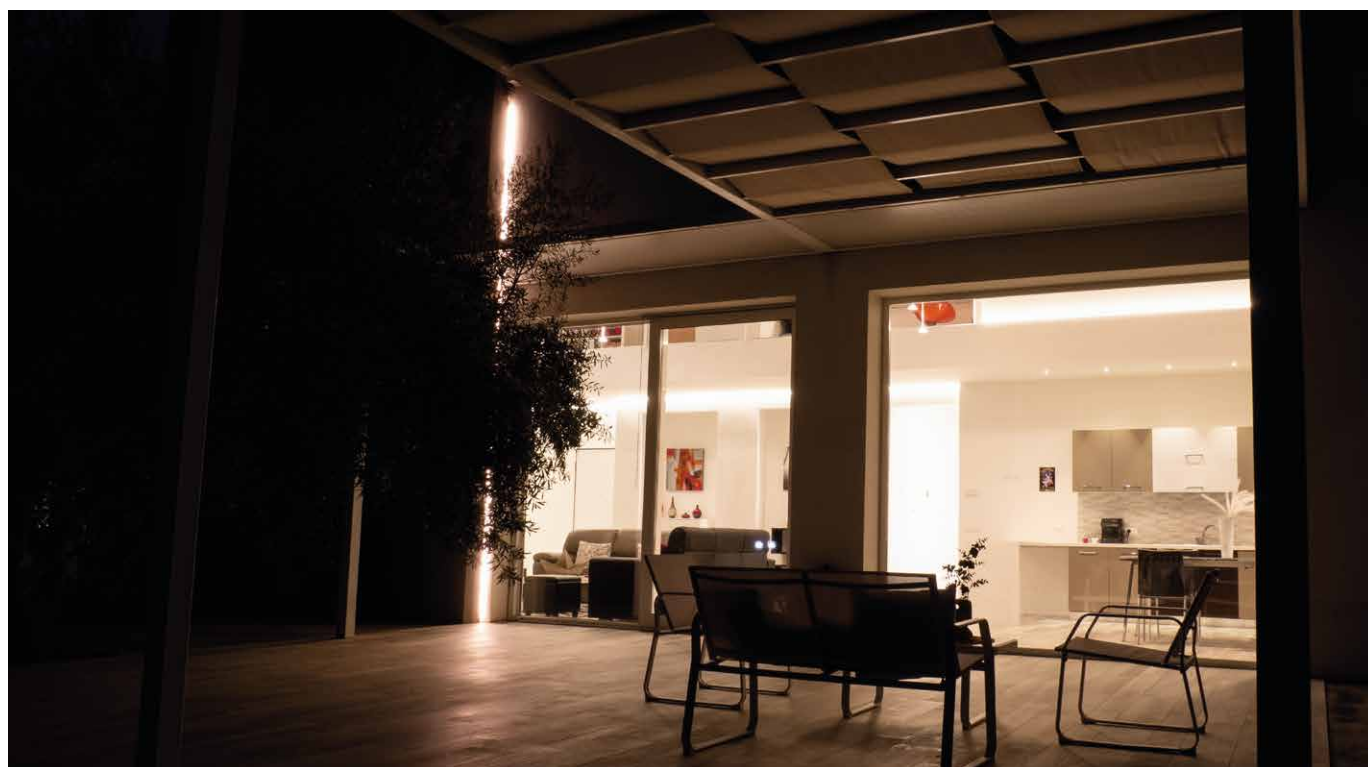
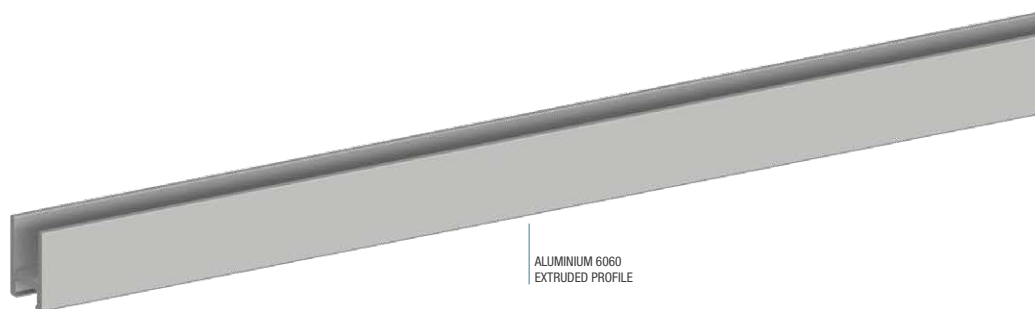

1:1 SCALE

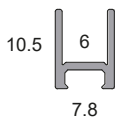

BASIC CODES

PA.H3.

LENGTH

- 1 1000mm
- 2 2000mm
- 3 3000mm

FINISHES

- 1 Matt white RAL9003
- 2 Matt black RAL9005
- 7 Brushed aluminium

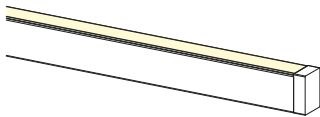
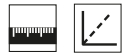

BASIC CODES

SH3.

FINISHES

- 1 White
- 2 Matt black
- 7 Brushed aluminium

Side aluminium closing support. Easy and quick to install, by exerting a slight side pressure.

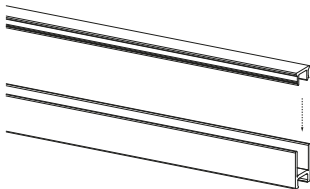

BASIC CODES

PA.0006OP.

LENGTH

- 1 1000mm brushed
- 2 2000mm brushed
- 3 3000mm brushed

Brushed snap-on diffuser. The diffuser can be easily removed for maintenance operations.

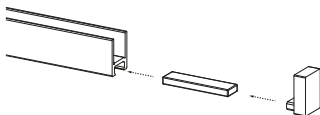

BASIC CODES

NDL40XP5X2

Magnets to glue on for fixing on smooth metal surfaces.

NB. We recommend No. 1 magnet every 150mm (Max. attraction force 1.60kg).

Code example: H3 Profile + 1000mm Length + Brushed Aluminium Finish = Code: PA.H3.17

IOTA

Anodized aluminium 6060 extruded profile, designed and produced to be flush-mounted on plasterboard surfaces; its small size and recessed diffuser create an almost-invisible light source, which enhances the luminous effect and draws beams of light on the ceiling and on the walls. Extremely easy to install, thanks to the brushed snap-in diffuser and fixing springs. Ideal to house and dissipate LED Strips, create new and unique light effects anywhere, with any interior, thanks to its special recessed anti-glare screen.

 EXTRUDED IN ITALY

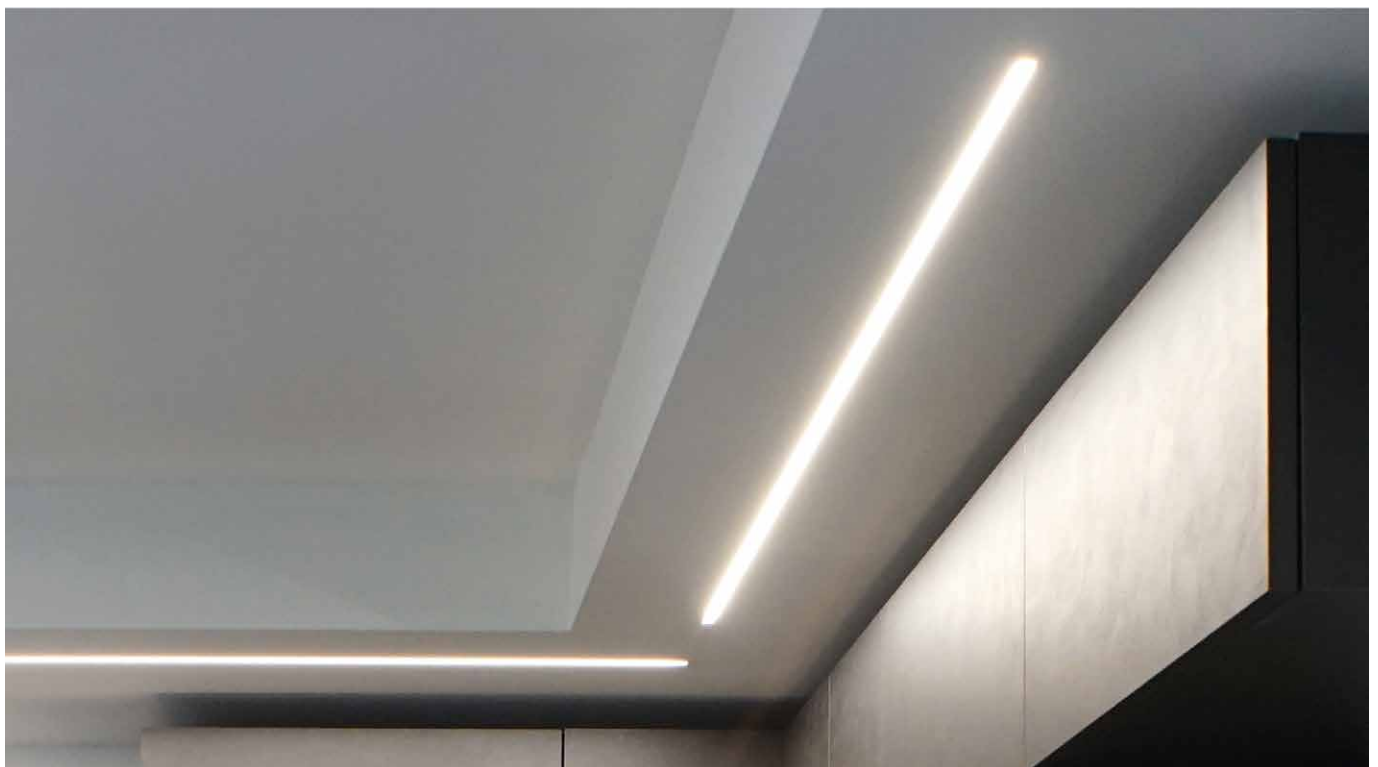
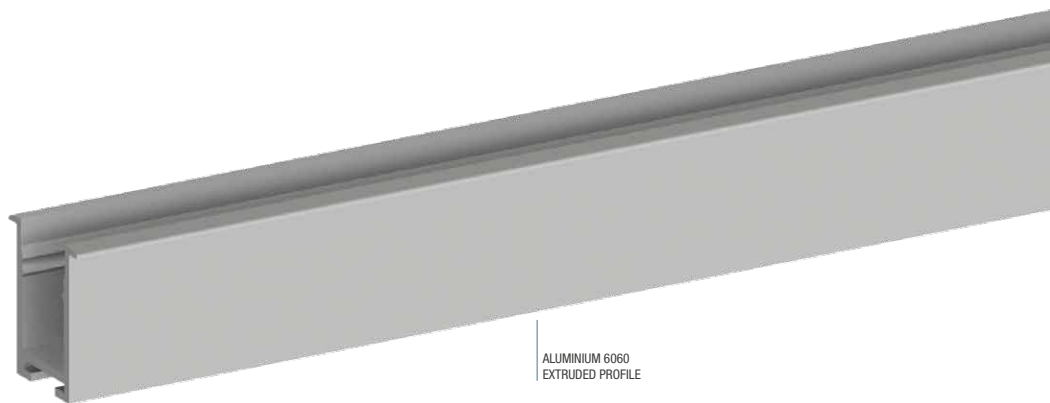

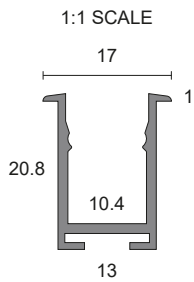

BASIC CODES

PA.IOTA.

LENGTH

- 1 1000mm
- 2 2000mm
- 3 3000mm

FINISHES

- 1 Matt white RAL9003
- 2 Matt black RAL9005
- 7 Brushed aluminium

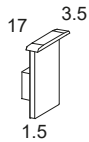
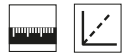

BASIC CODES

SI01.

FINISHES

- 1 White
- 2 Matt black
- 5 Grey
- 7 Brushed aluminium

Side ABS closing support. Easy and quick to install, by exerting a slight side pressure.

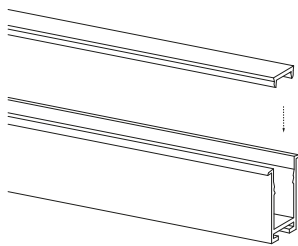

BASIC CODES

PA.12PE41.

LENGTH

- 1 1000mm brushed
- 2 2000mm brushed
- 3 3000mm brushed

Brushed snap-on diffuser. The diffuser can be easily removed for maintenance operations.

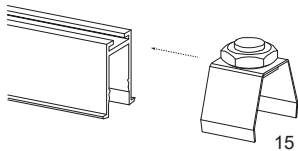

BASIC CODES

PA.GG08

Flash-mounting steel fixing clips. With the spring installed on the back of the profile, it provides an excellent seal on plasterboard or wooden panels.

NB. We recommend No. 1 Clip per 500mm

Code example: IOTA Profile + 1000mm Length + Brushed Aluminium Finish = Code: PA.IOTA.17

Small-size anodized aluminium 6060 extruded profile, designed and produced to be installed on very thin surfaces. Extremely easy to install, thanks to the brushed snap-in diffuser and side supports. Ideal to house and dissipate LED Strips, and especially suited to illuminate and embellish kitchen and bathroom cabinets, under-wall cupboards, furniture, closets, shelves and display cases. It can also be surface-mounted on the wall, vertically and horizontally.

 EXTRUDED IN ITALY

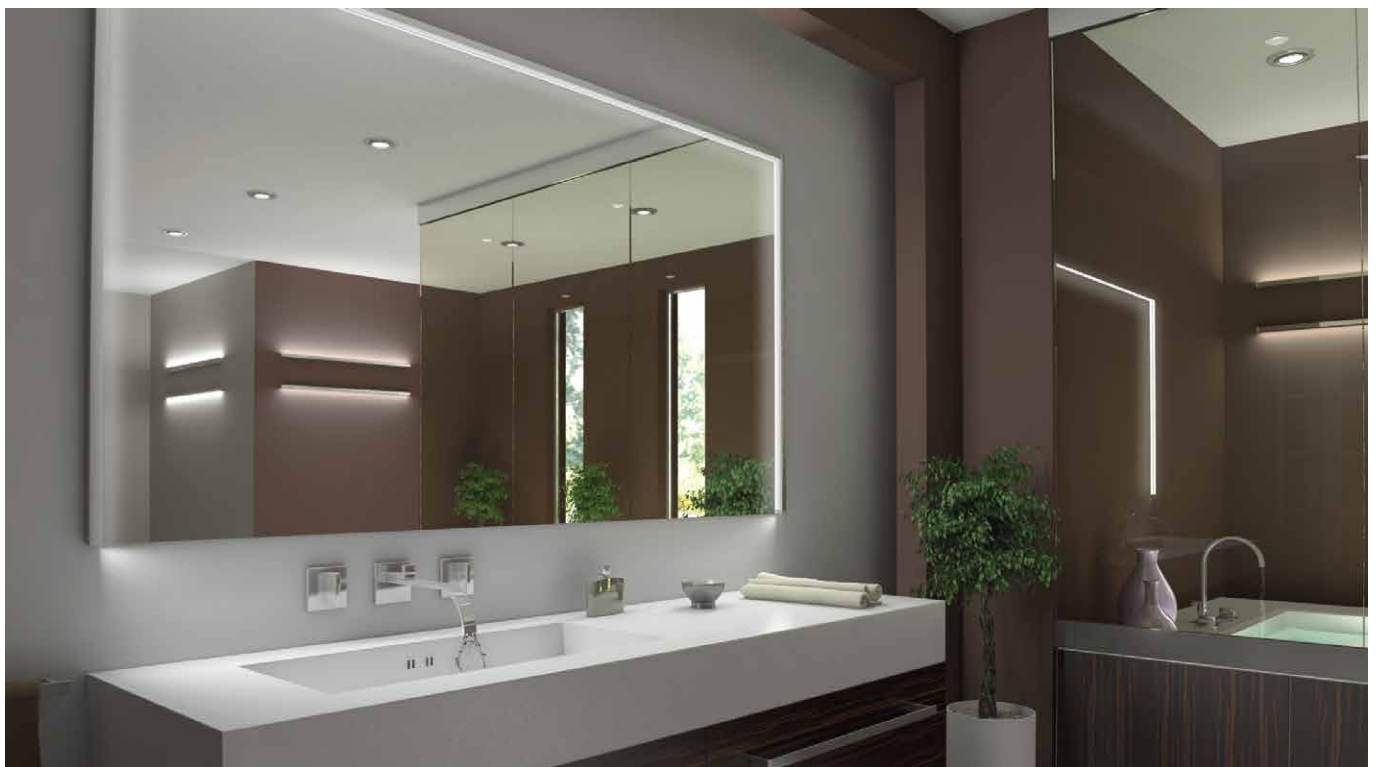
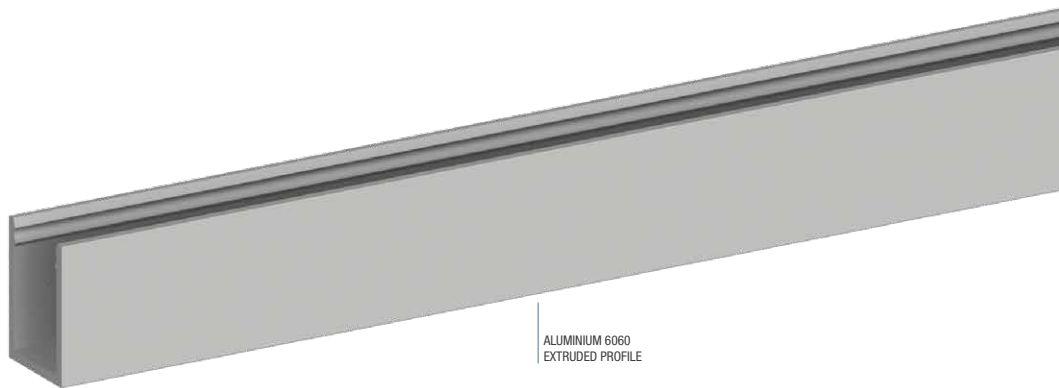

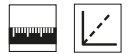

1:1 SCALE

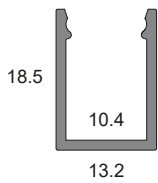

BASIC CODES

PA.JEY.

LENGTH

- 1 1000mm
- 2 2000mm
- 3 3000mm

FINISHES

- 1 Matt white RAL9003
- 2 Matt black RAL9005
- 7 Brushed aluminium

BASIC CODES

SJ01.P.

FINISHES

- 1 White
- 2 Matt black
- 5 Grey
- 7 Brushed aluminium

Side ABS closing support. Easy and quick to install, by exerting a slight side pressure.

2

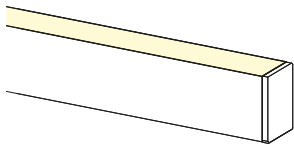

10

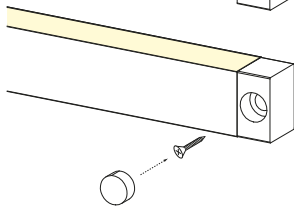

10

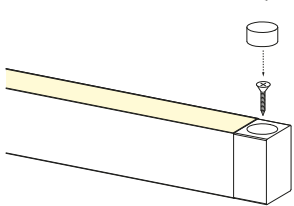

BASIC CODES

SJ02.

FINISHES

- 1 White
- 2 Matt black
- 7 Brushed aluminium

Closing and wall-mounting side support. Made of aluminium. Easy to install, thanks to the M3x20 screw hidden in the cover cap.

BASIC CODES

SJ03.

FINISHES

- 1 White
- 2 Matt black
- 7 Brushed aluminium

Closing and surface-mounting side support. Made of aluminium. Easy to install, thanks to the M3x20 screw hidden in the cover cap.

BASIC CODES

PA.12PE41.

LENGTH

- 1 1000mm brushed
- 2 2000mm brushed
- 3 3000mm brushed

Brushed snap-on diffuser. The diffuser can be easily removed for maintenance operations.

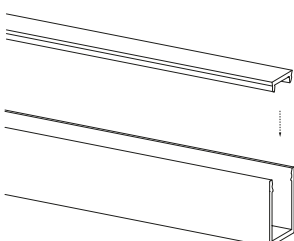

Code example: JEY Profile + 1000mm Length + Brushed Aluminium Finish = Code: PA.JEY.17

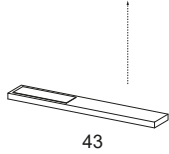
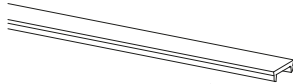
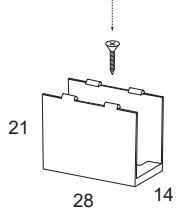
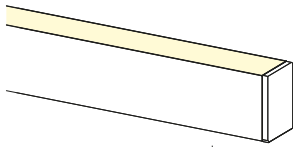

BASIC CODES

SJ04.8

Transparent polycarbonate surface-mounted fixing clip for the JEY profile. Supplied with M3x20 screw.
Snap-in profile mounting.

NB. We recommend No. 1 Clip per 500mm

BASIC CODES

TC22

Rectangular electronic device with ON/OFF TOUCH system. The LED can be switched ON/OFF by gently touching the sensitive device section. To be installed inside the profile, in contact with the diffuser, with the double-sided tape supplied (12Vdc and 24Vdc 3A max.)

Code example: JEY Profile + 1000mm Length + Brushed Aluminium Finish = Code: PA.JEY.17



KAPPA

Anodized 6060 aluminium extruded profile, designed and produced to be used in a wide variety of situations. Its size, shape and extreme ease of installation allow creating several types of sophisticated and prominent light sources. The accessories make the extruded profile even more versatile, by providing several installation options, such as suspension, vertical or horizontal wall lamp, or floor lamp. Ideal to house and dissipate LED Strips, including high-density models. The internal compartment can house the power supply unit.

■ ■ EXTRUDED IN ITALY

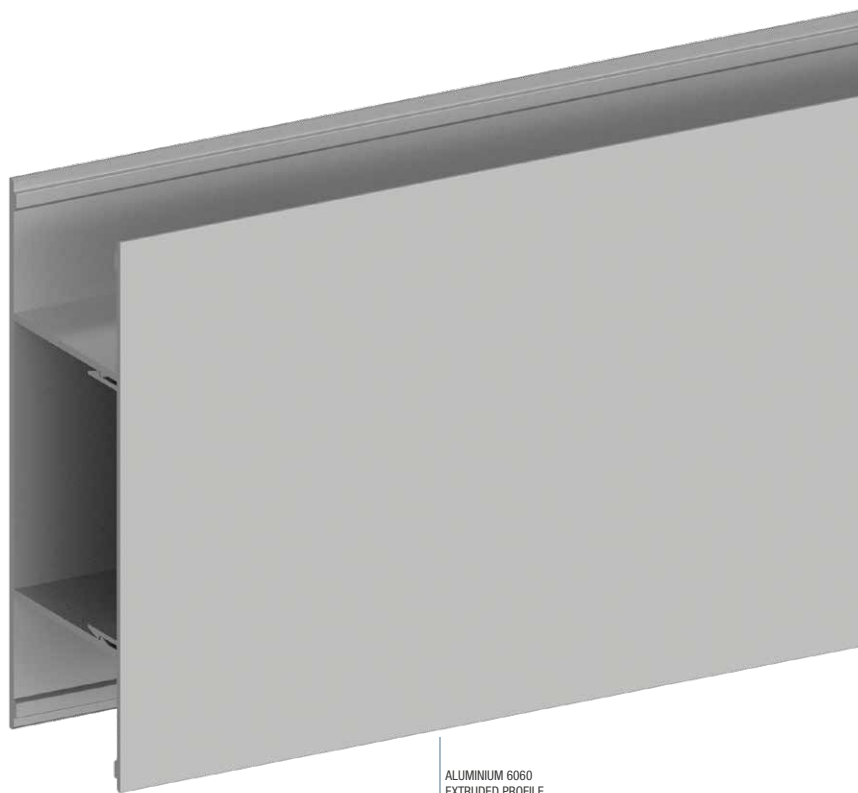

ALUMINIUM 6060
EXTRUDED PROFILE



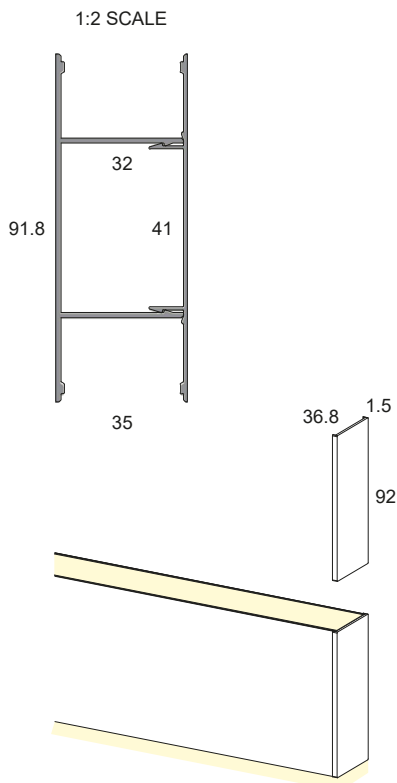

BASIC CODES

PA.KAPPA.

LENGTH

- 1 1000mm
- 2 2000mm
- 3 3000mm

FINISHES

- 1 Matt white RAL9003
- 2 Matt black RAL9005
- 7 Brushed aluminium

BASIC CODES

SK01.

FINISHES

- 1 White
- 2 Matt black
- 7 Brushed aluminium

Side aluminium closing support. Easy and quick to install, by exerting a slight side pressure.

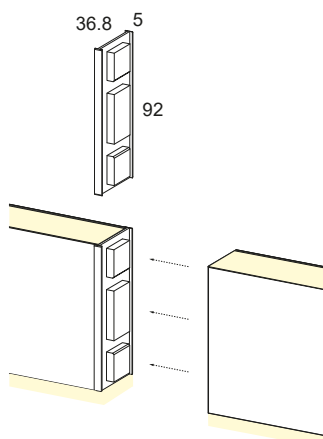

BASIC CODES

SK.05.

FINISHES

- 1 White
- 2 Matt black
- 7 Brushed aluminium

Side aluminium closing support for profile junction. Easy and quick to install, by exerting a slight side pressure.

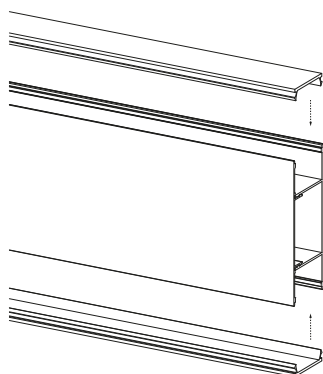

BASIC CODES

PA.PC30PE33.

LENGTH

- 1 1000mm brushed
- 2 2000mm brushed
- 3 3000mm brushed

- 1M 1000mm microprismatic
- 2M 2000mm microprismatic
- 3M 3000mm microprismatic

Brushed or microprismatic snap-on diffuser. The diffuser can be easily removed for maintenance operations.

Code example: KAPPA Profile + 1000mm Length + Brushed Aluminium Finish = Code: PA.KAPPA.17

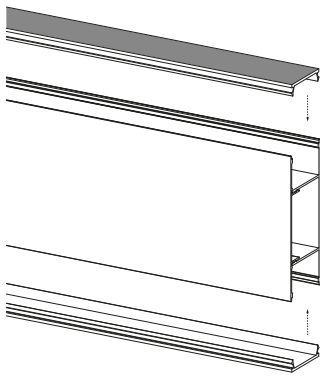

BASIC CODES

PA.2107.

LENGTH

- 1 1000mm
- 2 2000mm
- 3 3000mm

FINISHES

- 1 Matt white RAL9003
- 2 Matt black RAL9005
- 7 Brushed aluminium

Snap-in aluminium cover. The cover can be used to create a lightless zone.

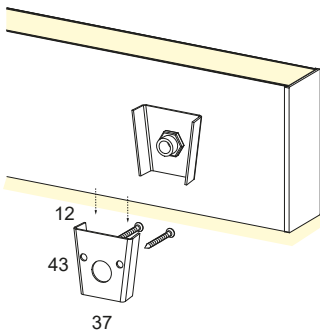

BASIC CODES

SK.06.

FINISHES

- 1 White
- 2 Matt black
- 5 Grey

Iron wall-mounting brackets. Easy to install with the plugs supplied.

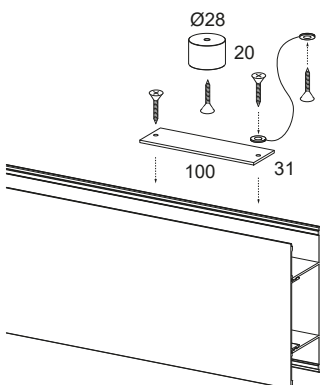

BASIC CODES

SK03.M

Magnetic surface-mounted system, with accessories and safety rope.

NB. No. 1 magnet required every 800mm (Max. attraction force 5.20kg).

Code example: KAPPA Profile + 1000mm Length + Brushed Aluminium Finish = Code: PA.KAPPA.17



MILKY

Extra-small opal polycarbonate extruded profile, designed and produced to be installed also on low surfaces. Extremely easy to install, thanks to the slip-in aluminium tab. Available in different sizes, it is ideal to house and dissipate LED Strips, and especially suited to illuminate and embellish kitchen cabinets, under-wall cupboards, furniture, closets, shelves and display cases.

 EXTRUDED IN ITALY

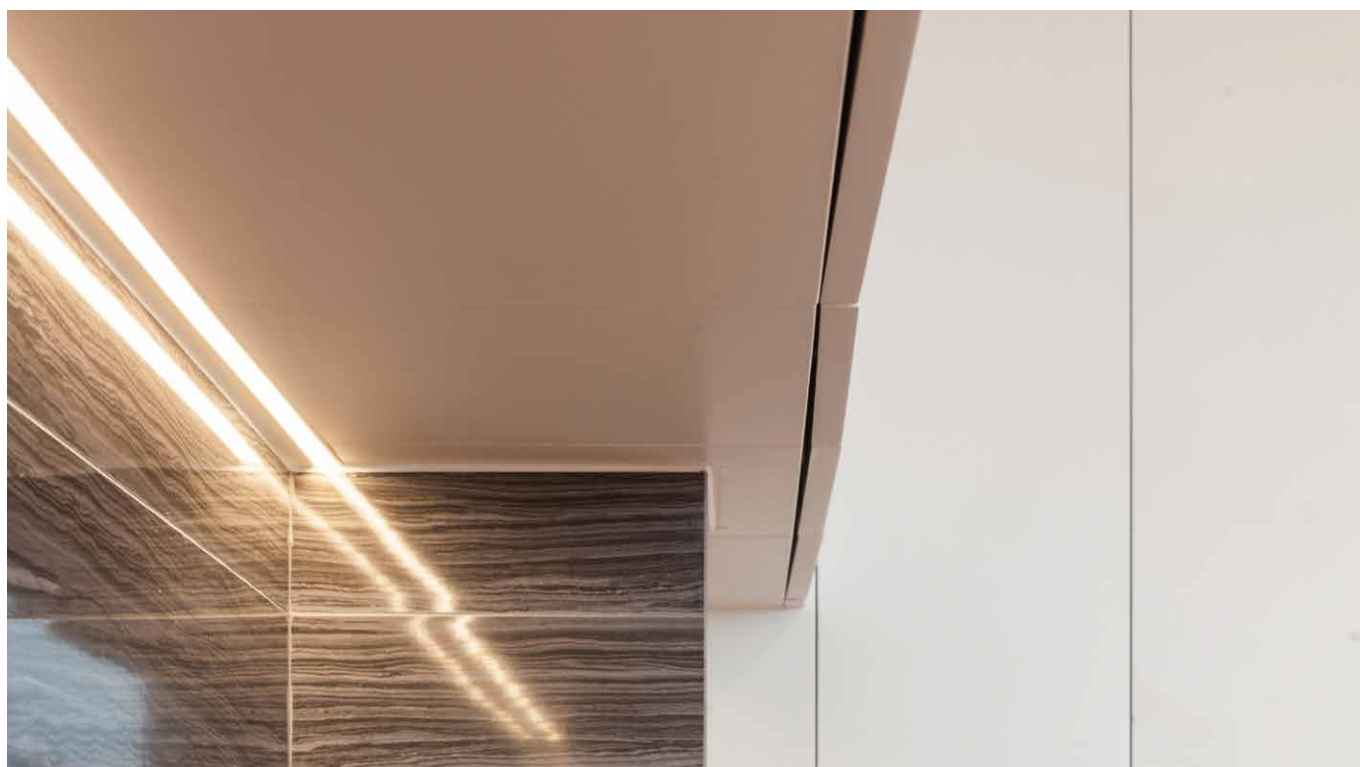
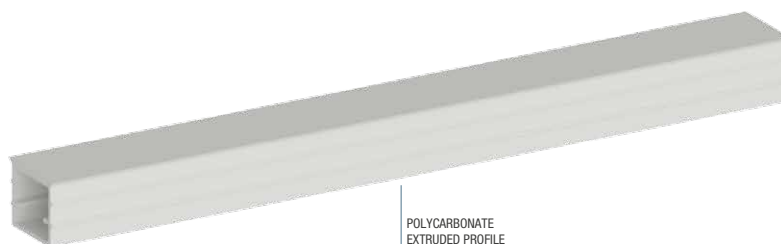

1:1 SCALE

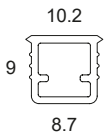

BASIC CODES

PA.MILKY.

LENGTH

- 1 1000mm
- 2 2000mm
- 3 3000mm

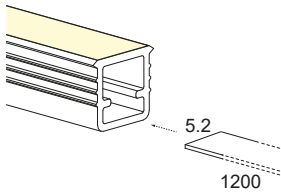
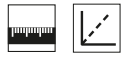

BASIC CODES

DSP.MILKY

1200mm slip-in aluminium heat sink.

NB. Compatible with LED Strips up to 5mm wide.

Code example: MILKY profile + 1000mm Length = Code: PA.MILKY.1

MINI

Small-size anodized aluminium 6060 extruded profile, designed and produced to be installed on very thin surfaces. Extremely easy to install, thanks to the brushed snap-in diffuser and surface-mounting clips. Ideal to house and dissipate LED Strips, and especially suited to illuminate and embellish kitchen and bathroom cabinets, under-wall cupboards, furniture, closets, shelves and display cases.

 EXTRUDED IN ITALY

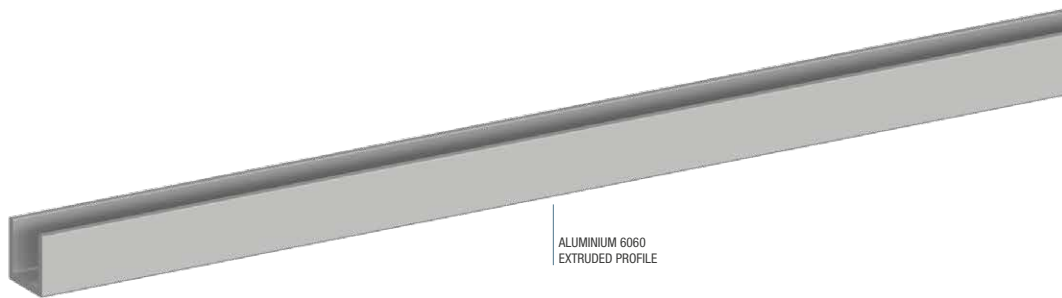

1:1 SCALE



BASIC CODES

PA.MINI.

LENGTH

- 1 1000mm
- 2 2000mm
- 3 3000mm

FINISHES

- 1 Matt white RAL9003
- 2 Matt black RAL9005
- 7 Brushed aluminium

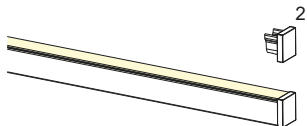
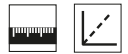

BASIC CODES

SN01.

FINISHES

- 1 White
- 2 Matt black
- 5 Grey
- 7 Brushed aluminium

Side ABS closing support. Easy and quick to install, by exerting a slight side pressure.

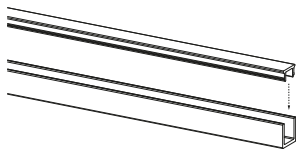

BASIC CODES

PA.0006OP.

LENGTH

- 1 1000mm brushed
- 2 2000mm brushed
- 3 3000mm brushed

Brushed snap-on diffuser. The diffuser can be easily removed for maintenance operations.

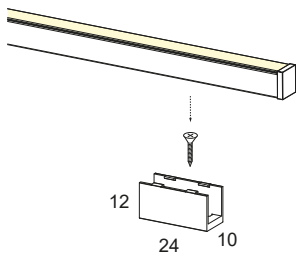

BASIC CODES

SN02.8

Transparent polycarbonate surface-mounted fixing clip for the MINI profile. Supplied with M3x20 screw. Snap-in profile mounting.

NB. We recommend No. 1 Clip per 500mm

Code example: MINI Profile + 1000mm Length + Brushed Aluminium Finish = Code: PA.MINI.17

OMEGA

Small-size anodized aluminium 6060 extruded profile, designed and produced to be installed or flush-mounted on very thin surfaces. Extreme versatility and adaptability, ensured by a wide range of accessories that allow several different combinations. Ideal to house and dissipate LED Strips, and especially suited to illuminate and embellish kitchen and bathroom cabinets, under-wall cupboards, furniture, closets, shelves and display cases.

 EXTRUDED IN ITALY

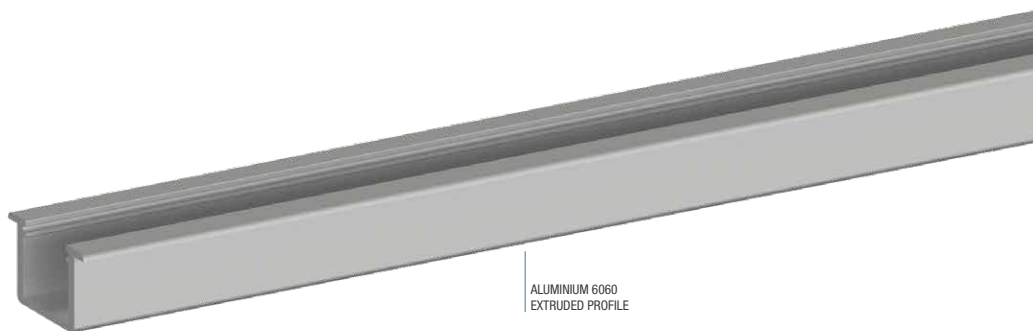

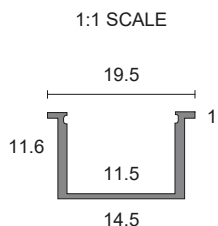

BASIC CODES

PA.OMEGA.

LENGTH

- 1 1000mm
- 2 2000mm
- 3 3000mm

FINISHES

- 1 Matt white RAL9003
- 2 Matt black RAL9005
- 7 Brushed aluminium

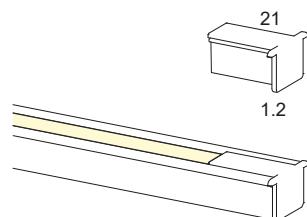

BASIC CODES

SS01.

FINISHES

- 1 White
- 2 Matt black
- 5 Grey
- 7 Brushed aluminium

FUNCTIONS

- C** Closure

Side ABS closing support. Easy and quick to install, by exerting a slight side pressure.

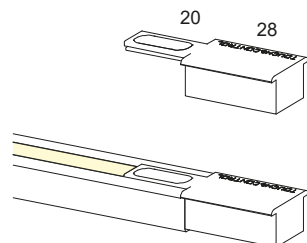

BASIC CODES

SS01.

FINISHES

- 1 White
- 2 Matt black
- 5 Grey
- 7 Brushed aluminium

FUNCTIONS

- T** ON/OFF Touch closure

Side ABS closing support with Touch device. The LED can be switched ON and OFF with a slight touch. (12Vdc and 24Vdc 4A max.)

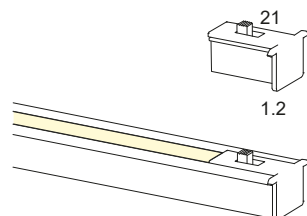

BASIC CODES

SS01.

FINISHES

- 1 White
- 2 Matt black
- 5 Grey
- 7 Brushed aluminium

FUNCTIONS

- I** ON/OFF switch closure

Side ABS closing support with ON/OFF switch.

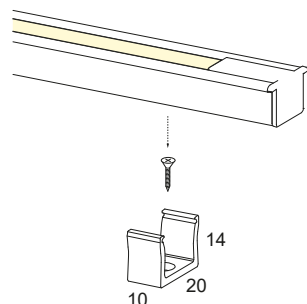

BASIC CODES

SS06T

Transparent polycarbonate surface-mounted fixing clip for the OMEGA profile. Supplied with M2.5x12 screw. Snap-in profile mounting.

NB. We recommend No. 1 Clip per 500mm

Code example: OMEGA Profile + 1000mm Length + Brushed Aluminium Finish = Code: PA.OMEGA.17

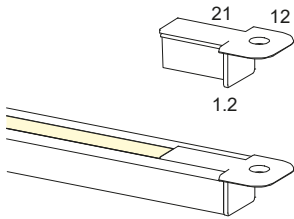

BASIC CODES

SS02.

FINISHES

- 1 White
- 2 Matt black
- 5 Grey
- 7 Brushed aluminium

FUNCTIONS

- C** Closure and fixing

Side closing support and ABS flush-mounting, Easy and quick to install, by exerting a slight side pressure.

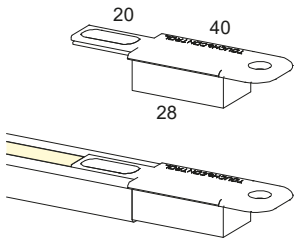

BASIC CODES

SS02.

FINISHES

- 1 White
- 2 Matt black
- 5 Grey
- 7 Brushed aluminium

FUNCTIONS

- T** ON/OFF Touch closure and fixing

Side closing support and ABS flush-mounting, with ON/OFF Touch device. The LED can be switched ON and OFF with a slight touch. (12Vdc and 24Vdc 4A max.)

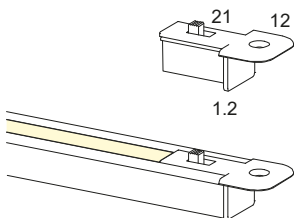

BASIC CODES

SS02.

FINISHES

- 1 White
- 2 Matt black
- 5 Grey
- 7 Brushed aluminium

FUNCTIONS

- I** ON/OFF closure and fixing

Side closing support and ABS flush-mounting, with ON/OFF switch.

Code example: OMEGA Profile + 1000mm Length + Brushed Aluminium Finish = Code: PA.OMEGA.17

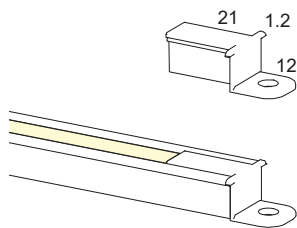

BASIC CODES

SS03.

FINISHES

- 1 White
- 2 Matt black
- 5 Grey
- 7 Brushed aluminium

FUNCTIONS

- C** Closure and fixing

ABS closing and surface-mounting side support. Easy and quick to install, by exerting a slight side pressure.

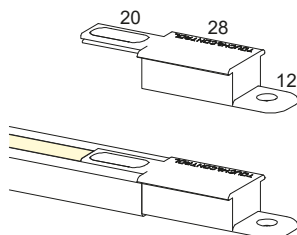

BASIC CODES

SS03.

FINISHES

- 1 White
- 2 Matt black
- 5 Grey
- 7 Brushed aluminium

FUNCTIONS

- T** ON/OFF Touch closure and fixing

Side closing support and ABS surface-mounting, with ON/OFF Touch device. The LED can be switched ON and OFF with a slight touch. (12Vdc and 24Vdc 4A max.)

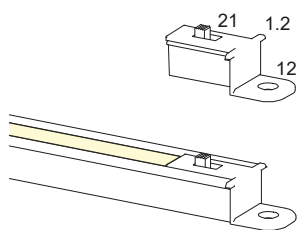

BASIC CODES

SS03.

FINISHES

- 1 White
- 2 Matt black
- 5 Grey
- 7 Brushed aluminium

FUNCTIONS

- I** ON/OFF switch closure and fixing

Side closing support and ABS surface-mounting, with ON/OFF switch.

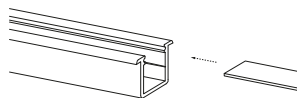

BASIC CODES

PA.01NA11.

LENGTH

- 1** 1000mm brushed
- 2** 2000mm brushed
- 3** 3000mm brushed

Brushed diffuser to insert on the profile internal slots.

Code example: OMEGA Profile + 1000mm Length + Brushed Aluminium Finish = Code: PA.OMEGA.17

QU

Small-size opal polycarbonate extruded profile, designed and produced to be flush-mounted also on very thin surfaces. Extremely easy to install, thanks to the slip-in aluminium tab. Available in different sizes, it is ideal to house and dissipate LED Strips, and especially suited to illuminate and embellish kitchen and bathroom cabinets, under-wall cupboards, furniture, closets, shelves and display cases.

 EXTRUDED IN ITALY

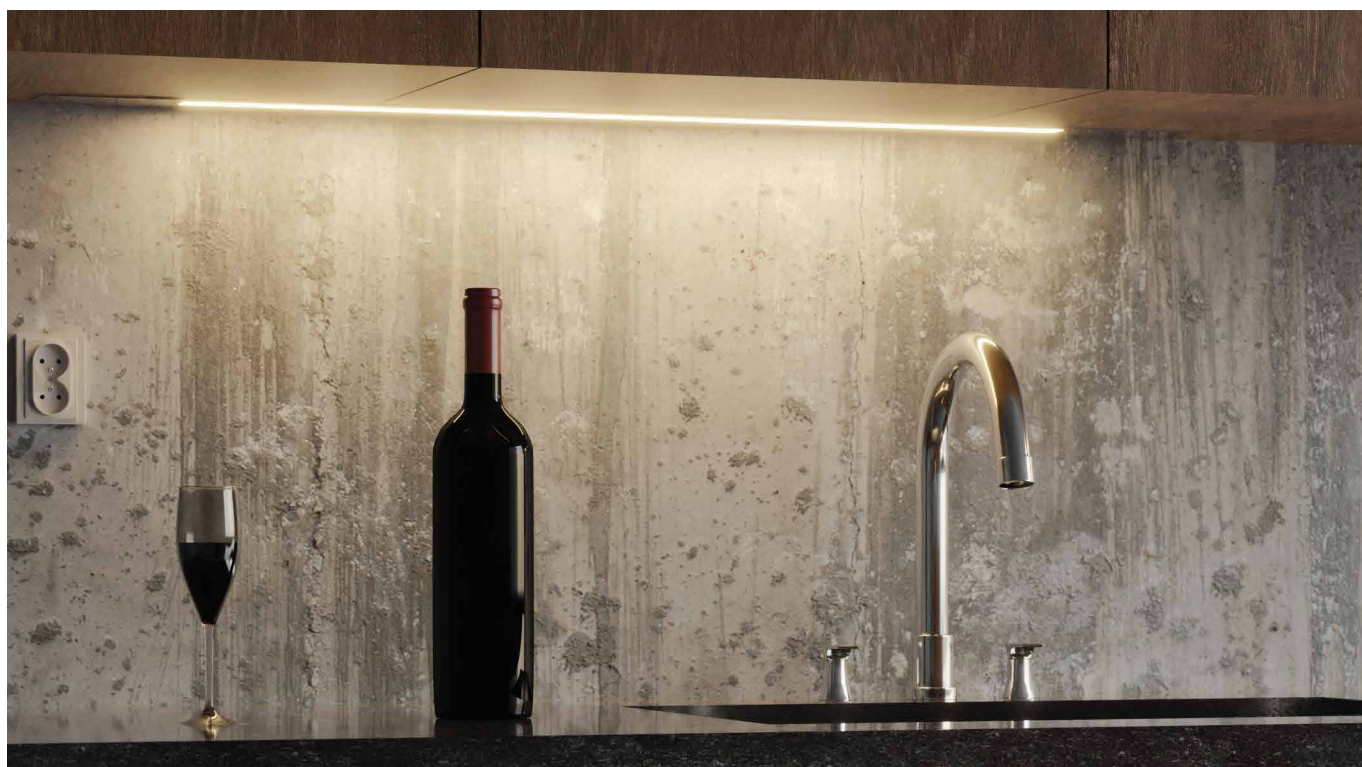
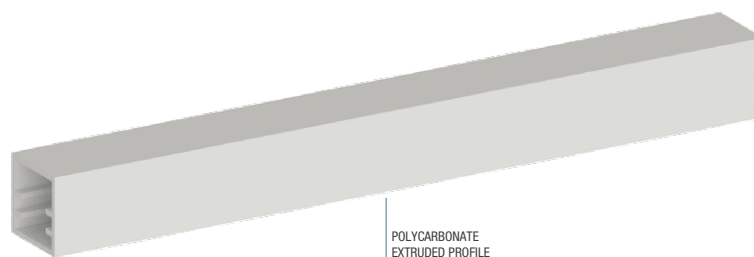

1:1 SCALE

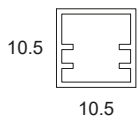

BASIC CODES

PA.QU.

LENGTH

- 1 1000mm
- 2 2000mm
- 3 3000mm

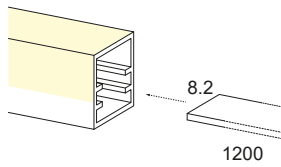
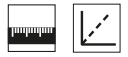

BASIC CODES

DSP.QU

1200mm slip-in aluminium heat sink.

NB. Compatible with LED Strips up to 8mm wide.

Code example: QU profile + 1000mm Length = Code: PA.QU.1

RASO

Anodised aluminium 6060 extruded profile with direct emission light output, ideal for flush-mounting on plasterboard. Extremely easy to install, thanks to the reinforced and knurled fixing flaps for improved grip, the snap-in diffuser, and the flush-mounted side supports. Necessary to dissipate the LED Strips correctly, and ideal for extended and even light beams.

 EXTRUDED IN ITALY



ALUMINIUM 6060
EXTRUDED PROFILE

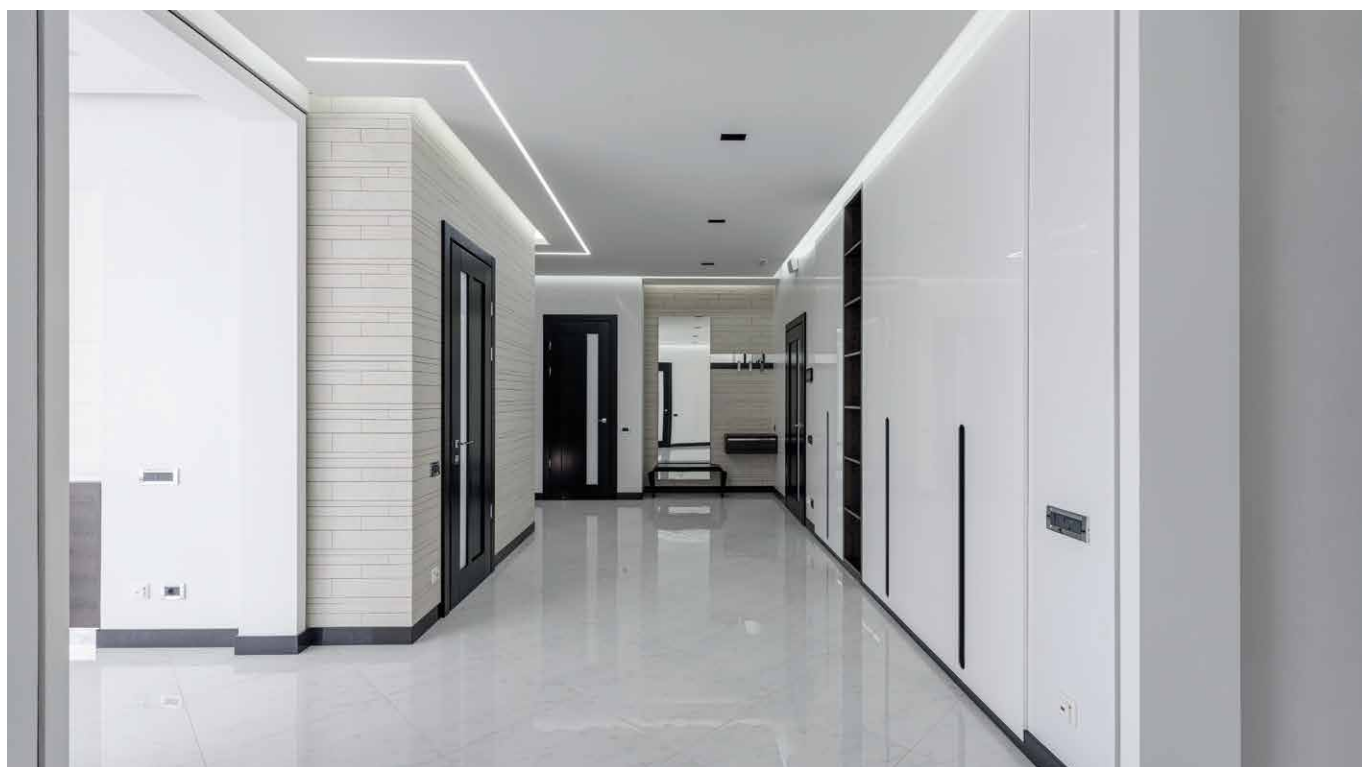

1:1 SCALE

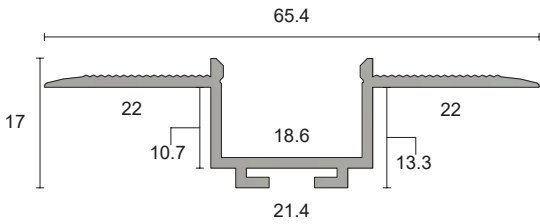

BASIC CODES

PA.RASO.

LENGTH

- 1 1000mm
- 2 2000mm
- 3 3000mm

FINISHES

- 1 Matt white RAL9003
- 2 Matt black RAL9005
- 7 Brushed aluminium

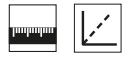

2

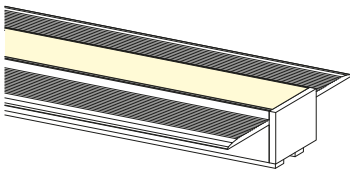

BASIC CODES

SP01.

FINISHES

- 1 White
- 2 Matt black
- 7 Brushed aluminium

Side aluminium closing support. Easy and quick to install, by exerting a slight side pressure.

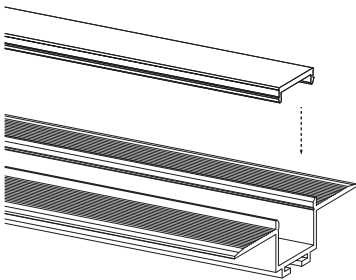

BASIC CODES

PA.20PE10.

LENGTH

- 1 1000mm brushed
- 2 2000mm brushed
- 3 3000mm brushed

- 1M 1000mm microprismatic
- 2M 2000mm microprismatic
- 3M 3000mm microprismatic

Brushed or microprismatic snap-on diffuser. The diffuser can be easily removed for maintenance operations.

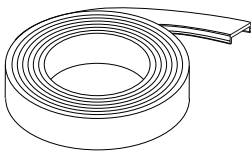

BASIC CODES

PA.20PE10.R

LENGTH

- 10 10-meter brushed

Brushed snap-on diffuser. The diffuser can be easily removed for maintenance operations. Provided in 10-meter reels with protective film.

Code example: RASO Profile + 1000mm Length + Brushed Aluminium Finish = Code: PA.RASO.17

REFLEX

Small-size anodized aluminium 6060 extruded profile with indirect light output, designed and produced to be flush-mounted even on very thin surfaces. Extremely easy to install, thanks to the brushed snap-in diffuser and side closure supports. Available in different sizes, it is ideal to house and dissipate LED Strips, and especially suited to illuminate and embellish kitchen and bathroom cabinets and panels, under-wall cupboards, furniture, closets, shelves and display cases.

 EXTRUDED IN ITALY

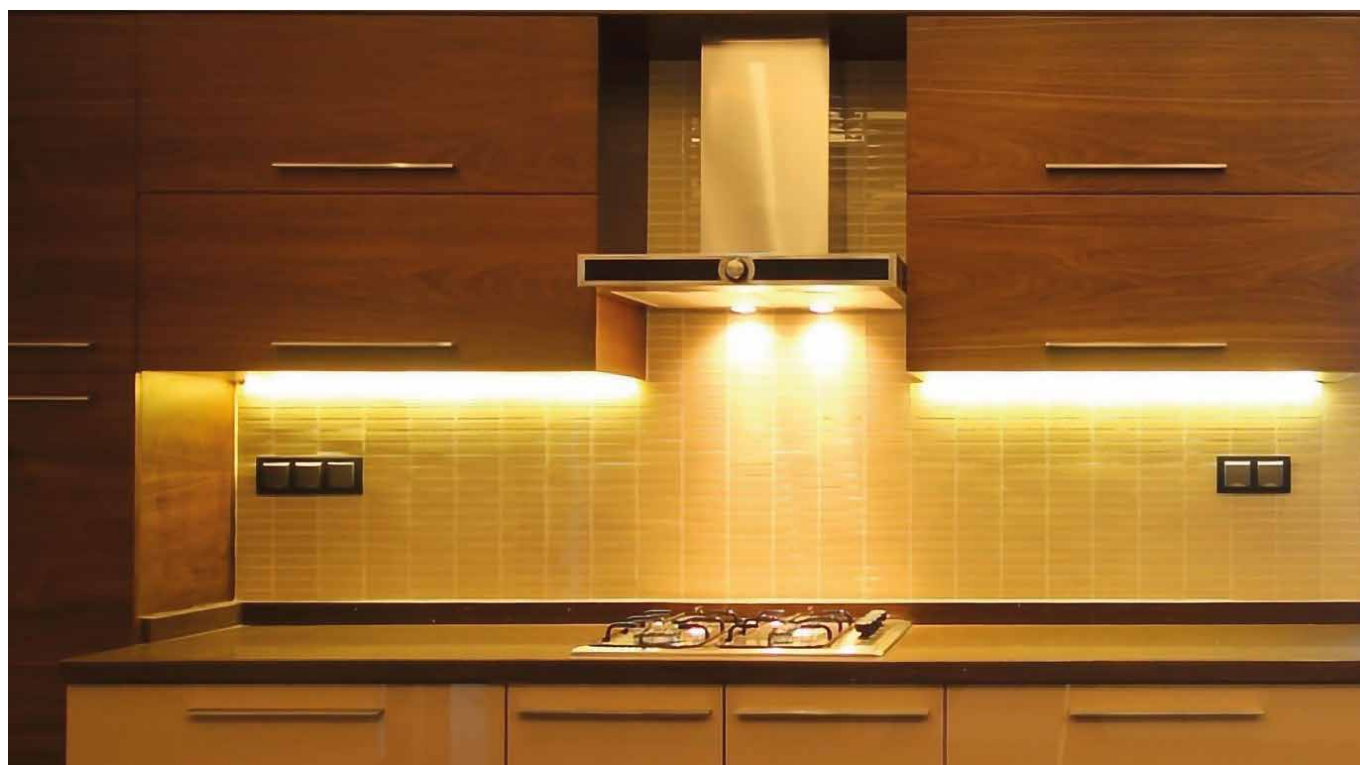
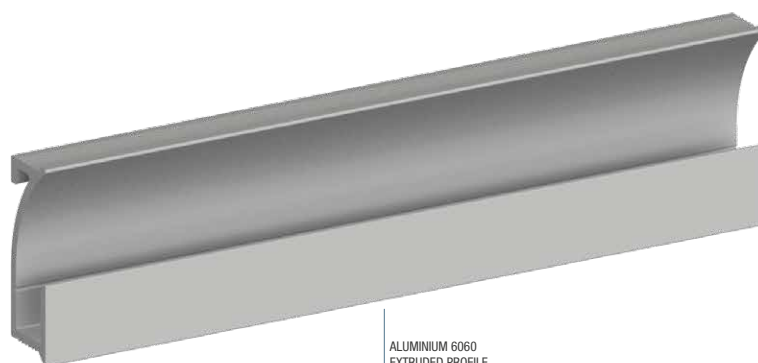

1:1 SCALE

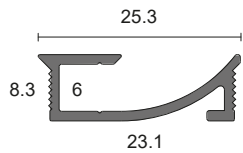

BASIC CODES

PA.REFLEX.

LENGTH

- 1 1000mm
- 2 2000mm
- 3 3000mm

FINISHES

- 1 Matt white RAL9003
- 2 Matt black RAL9005
- 7 Brushed aluminium

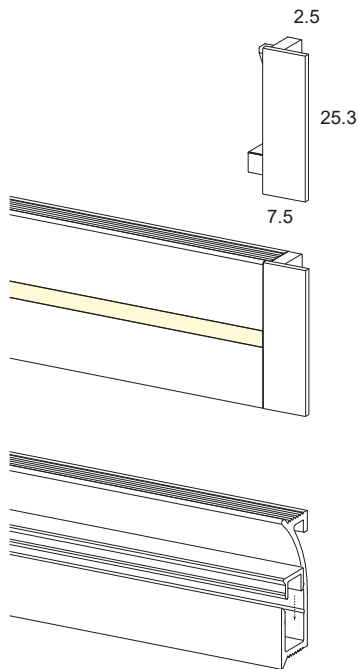
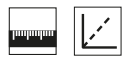

BASIC CODES

SR01.

FINISHES

- 1 White
- 2 Matt black
- 7 Brushed aluminium

Side aluminium closing support. Easy and quick to install, by exerting a slight side pressure.

BASIC CODES

PA.PL0420.

LENGTH

- 1 1000mm brushed
- 2 2000mm brushed
- 3 3000mm brushed

Brushed snap-on diffuser. The diffuser can be easily removed for maintenance operations.

Code example: REFLEX Profile + 1000mm Length + Brushed Aluminium Finish = Code: PA.REFLEX.17

RHO

Small-size anodized aluminium extruded profile, designed and produced to be installed on any surface. Extreme versatility and adaptability, ensured by a wide range of accessories that allow several different combinations. Easy to install surface- or flush-mounted, or as suspension.

Ideal to house and dissipate LED Strips, and especially suited to illuminate and embellish offices, rooms, hallways, kitchens and much more.

 EXTRUDED IN ITALY

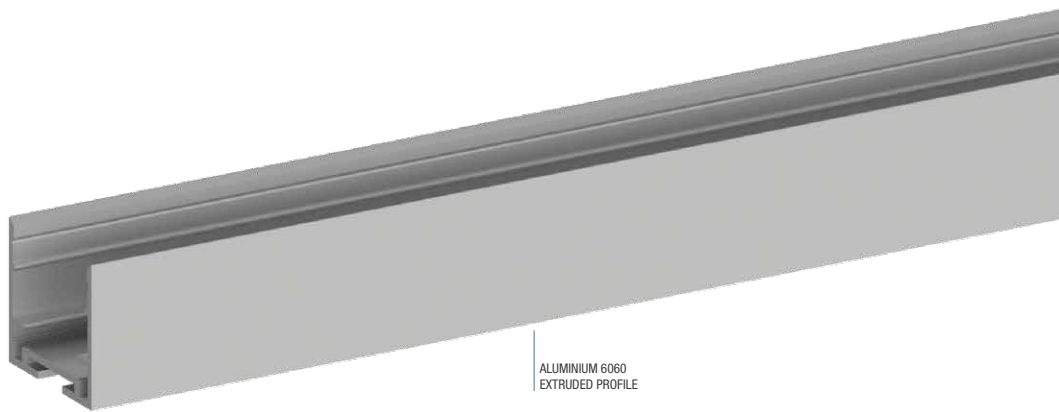

1:1 SCALE

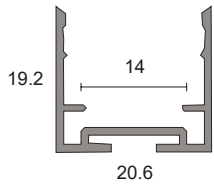

BASIC CODES

PA.RHO.

LENGTH

- 1 1000mm
- 2 2000mm
- 3 3000mm

FINISHES

- 1 Matt white RAL9003
- 2 Matt black RAL9005
- 7 Brushed aluminium

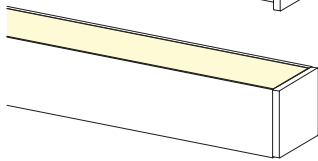
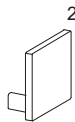
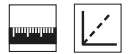

BASIC CODES

SY01.

FINISHES

- 1 White
- 2 Matt black
- 7 Brushed aluminium

Side aluminium closing support. Easy and quick to install, by exerting a slight side pressure.

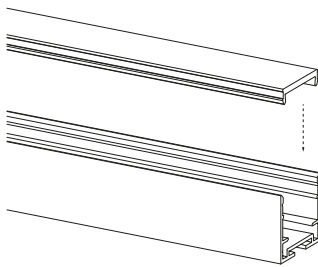

BASIC CODES

PA.20PE10.

LENGTH

- 1 1000mm brushed
- 2 2000mm brushed
- 3 3000mm brushed

- 1M 1000mm microprismatic
- 2M 2000mm microprismatic
- 3M 3000mm microprismatic

Brushed or microprismatic snap-on diffuser. The diffuser can be easily removed for maintenance operations.

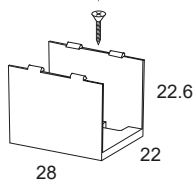
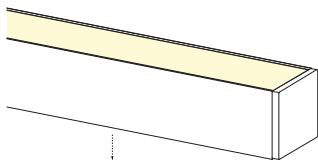

BASIC CODES

SY05.8

Transparent polycarbonate surface-mounted fixing clip for the RHO profile. It can be fixed on any surface. Supplied with M3x20 screw. Snap-in profile mounting.

NB. We recommend No. 1 Clip per 500mm

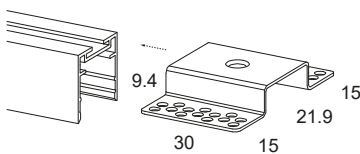

BASIC CODES

SY03

Support for RHO/Ypsilon profile flush-mounting installation. Install the support on the back of the profile and fix it to the 12mm plasterboard through self-tapping screws.

NB. We recommend No. 1 Clip per 500mm

Code example: RHO Profile + 1000mm Length + Brushed Aluminium Finish = Code: PA.RHO.17

SIGMA

Anodized aluminium 6060 extruded profile, designed and produced to be recess-mounted also on very small surfaces. Extremely easy to install, thanks to the brushed snap-in diffuser and side supports. Ideal to house and dissipate LED Strips, and especially suited to illuminate and embellish kitchens, under-wall cupboards, furniture, closets, shelves and plasterboard.

 EXTRUDED IN ITALY



1:1 SCALE

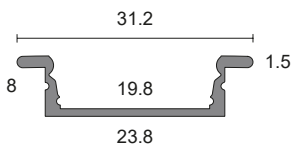

BASIC CODES

PA.SIGMA.

LENGTH

- 1 1000mm
- 2 2000mm
- 3 3000mm

FINISHES

- 1 Matt white RAL9003
- 2 Matt black RAL9005
- 7 Brushed aluminium

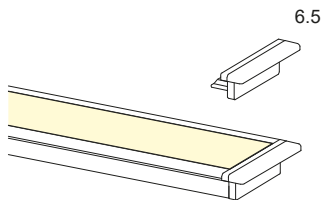
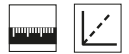

BASIC CODES

SG01.

FINISHES

- 1 White
- 2 Matt black
- 5 Grey
- 7 Brushed aluminium

Side closing support and ABS flush-mounting, Easy and quick to install, by exerting a slight side pressure.

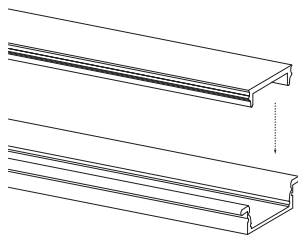

BASIC CODES

PA.13PE49.

LENGTH

- 1 1000mm brushed
- 2 2000mm brushed
- 3 3000mm brushed

Brushed snap-on diffuser. The diffuser can be easily removed for maintenance operations.

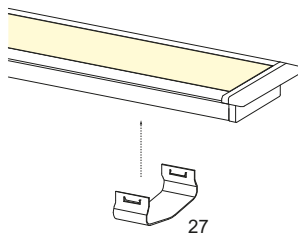

BASIC CODES

PA.GG06

Steel fixing clips for flush-mounting on wood or plasterboard.

NB. We recommend No. 1 Clip per 500mm

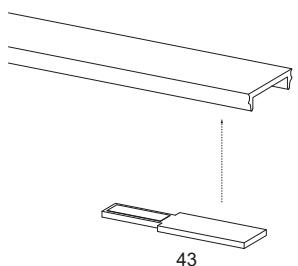

BASIC CODES

TC02

Rectangular electronic device with ON/OFF TOUCH system. The LED can be switched ON/OFF by gently touching the sensitive device section. To be installed inside the profile, in contact with the diffuser, with the double-sided tape supplied (12Vdc and 24Vdc 4A max.)

Code example: SIGMA Profile + 1000mm Length + Brushed Aluminium Finish = Code: PA.SIGMA.17

TAU

Anodized aluminium 6060 extruded profile, designed and manufactured to recessed-mounted on plasterboard; thanks to its size, it creates a bold and sophisticated light source. Extremely easy to install, thanks to the brushed snap-in diffuser, side supports, and fixing springs. Ideal to house and dissipate LED Strips, including high-density models, and especially suited to illuminate and embellish offices, rooms, hallways, kitchens and much more.

 EXTRUDED IN ITALY

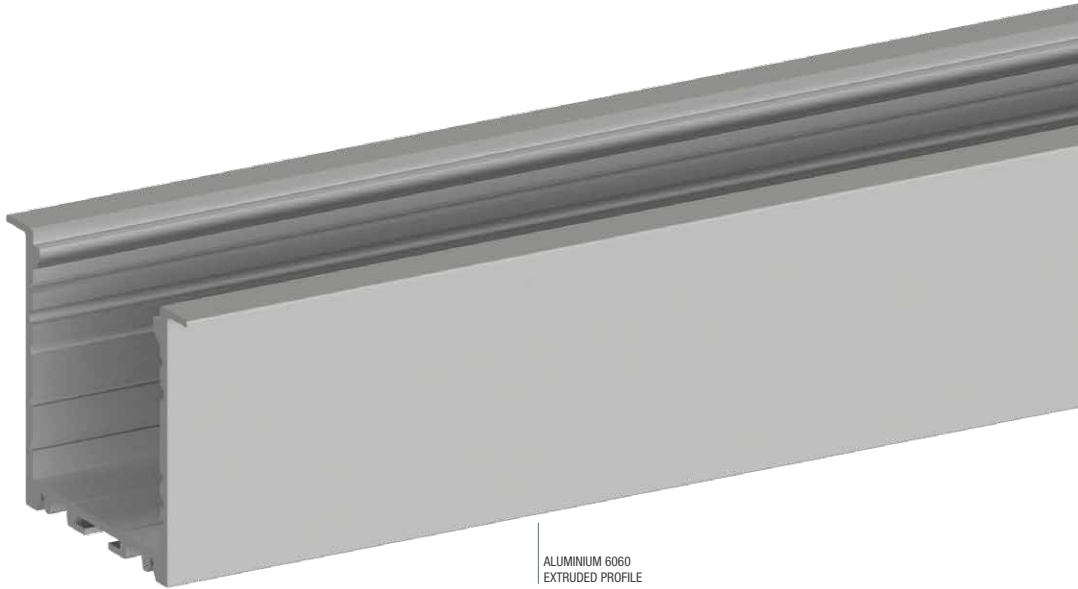

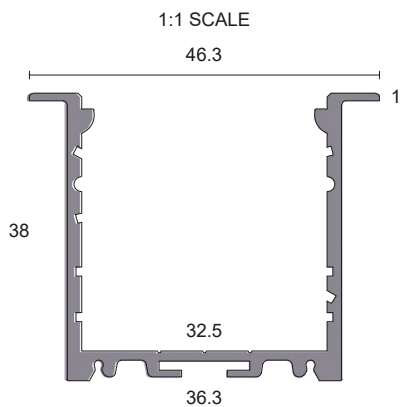

BASIC CODES

PA.TAU.

LENGTH

- 1 1000mm
- 2 2000mm
- 3 3000mm

FINISHES

- 1 Matt white RAL9003
- 2 Matt black RAL9005
- 7 Brushed aluminium

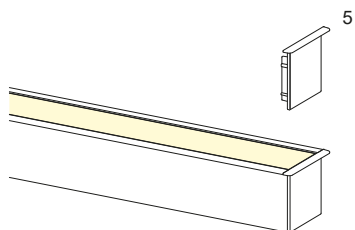

BASIC CODES

ST01.

FINISHES

- 1 White
- 2 Matt black
- 5 Grey
- 7 Brushed aluminium

Side closing support and ABS flush-mounting, Easy and quick to install, by exerting a slight side pressure.

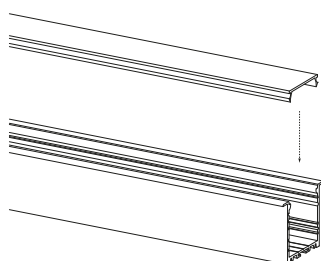

BASIC CODES

PA.PC30PE33.

LENGTH

- 1 1000mm brushed
- 2 2000mm brushed
- 3 3000mm brushed

- 1M 1000mm microprismatic
- 2M 2000mm microprismatic
- 3M 3000mm microprismatic

Brushed or microprismatic snap-on diffuser. The diffuser can be easily removed for maintenance operations.

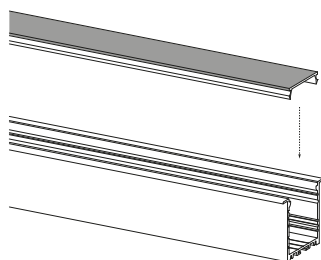

BASIC CODES

PA.2107.

LENGTH

- 1 1000mm
- 2 2000mm
- 3 3000mm

FINISHES

- 1 Matt white RAL9003
- 2 Matt black RAL9005
- 7 Brushed aluminium

Snap-in aluminium cover. The cover can be used to create a lightless zone where the power supply can be installed. Also, by drilling the cover, several LED Spotlights can be installed.

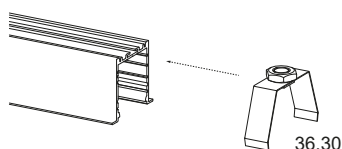

BASIC CODES

PA.GG04

Flash-mounting steel fixing clips. With the spring installed on the back of the profile, it provides an excellent seal on plasterboard or wooden panels.

NB. We recommend No. 1 Clip per 500mm

Code example: TAU Profile + 1000mm Length + Brushed Aluminium Finish = Code: PA.TAU.17

VEGA

Small-size anodized aluminium 6060 extruded angle profile, designed and produced to be installed with 45° light output. Extremely easy to install, thanks to the brushed snap-in diffuser and concealed magnets. Ideal to house and dissipate LED Strips, and especially suited to illuminate and embellish kitchen and bathroom cabinets, under-wall cupboards, furniture, closets, shelves and display cases.

 EXTRUDED IN ITALY



1:1 SCALE

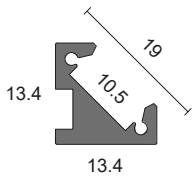

BASIC CODES

PA.VEGA.

LENGTH

- 1 1000mm
- 2 2000mm
- 3 3000mm

FINISHES

- 1 Matt white RAL9003
- 2 Matt black RAL9005
- 7 Brushed aluminium

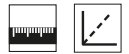

2.5

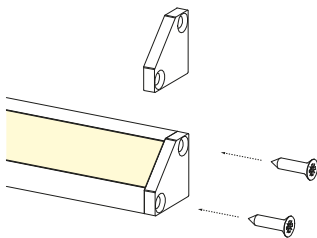

BASIC CODES

SVG1.

FINISHES

- 1 White
- 2 Matt black
- 7 Brushed aluminium

Side aluminium closing support. Easy and quick assembly with M2.2x8 screws supplied.

BASIC CODES

PA.12PE41.

LENGTH

- 1 1000mm brushed
- 2 2000mm brushed
- 3 3000mm brushed

Brushed snap-on diffuser. The diffuser can be easily removed for maintenance operations.

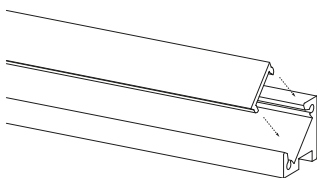

BASIC CODES

SVG2.8

Transparent polycarbonate clip with 12xM2.5 screws for surface mounting on a variety of surfaces.

NB. We recommend No. 1 Clip per 500mm

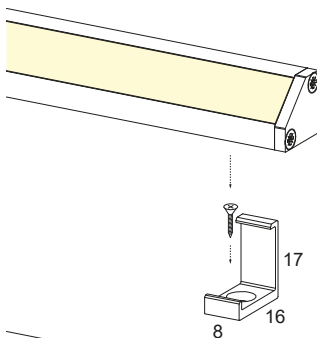

BASIC CODES

NDL40XP5X2

Magnets to glue on for fixing on smooth metal surfaces.

NB. We recommend No. 1 Magnet every 150mm

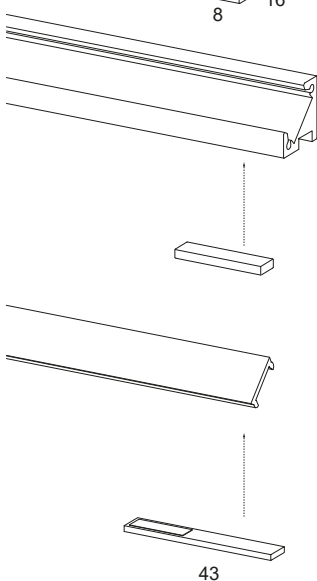

BASIC CODES

TC22

Rectangular electronic device with ON/OFF TOUCH system. The LED can be switched ON/OFF by gently touching the sensitive device section. To be installed inside the profile, in contact with the diffuser, with the double-sided tape supplied (12Vdc and 24Vdc 3A max.)

Code example: VEGA Profile + 1000mm Length + Brushed Aluminium Finish = Code: PA.VEGA.17

Anodised aluminium 6060 extruded profile with direct light output, designed and produced to be surface-mounted. Extremely easy to install, thanks to the brushed snap-in diffuser, side supports, and concealed clip. Available in several sizes, it is ideal to house and dissipate LED Strips.

 EXTRUDED IN ITALY

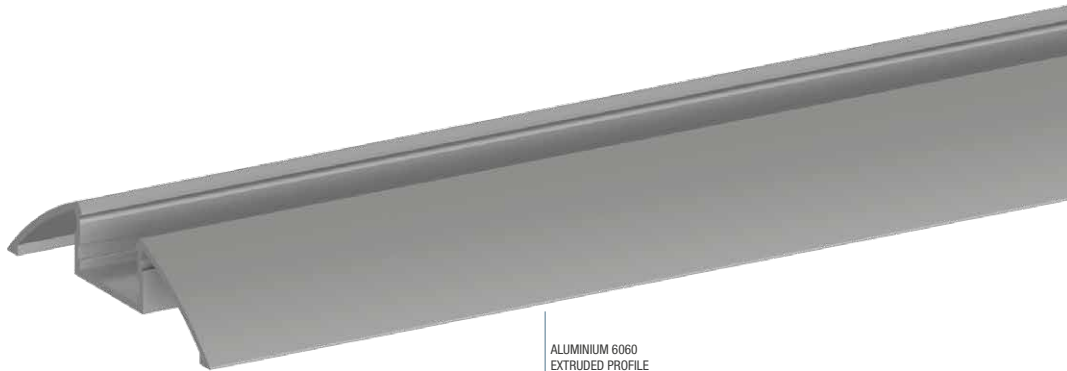

ALUMINIUM 6060
EXTRUDED PROFILE



1:1 SCALE

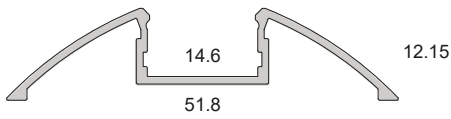

BASIC CODES

PA.VELA.

LENGTH

- 1 1000mm
- 2 2000mm
- 3 3000mm

FINISHES

- 1 Matt white RAL9003
- 2 Matt black RAL9005
- 7 Brushed aluminium

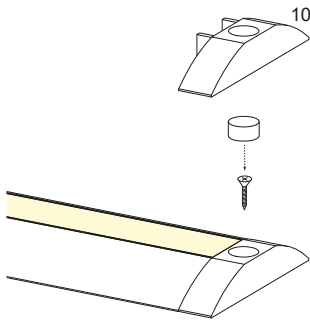
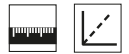

BASIC CODES

SVE01.

FINISHES

- 1 White
- 2 Matt black
- 5 Grey
- 7 Brushed aluminium

Hole fixing and closing side support for M3x20 screw and cover cap. Made of ABS.

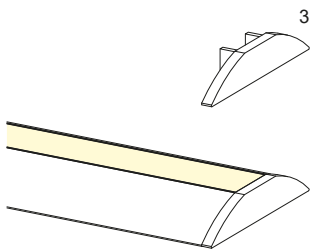

BASIC CODES

SVE02.

FINISHES

- 1 White
- 2 Matt black
- 7 Brushed aluminium

Side aluminium closing support. Easy and quick to install, by exerting a slight side pressure.

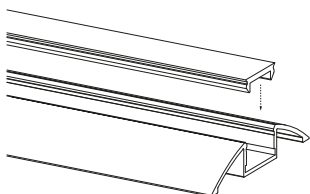

BASIC CODES

PA.13PE56.

LENGTH

- 1 1000mm brushed
- 2 2000mm brushed
- 3 3000mm brushed

Brushed snap-on diffuser. The diffuser can be easily removed for maintenance operations.

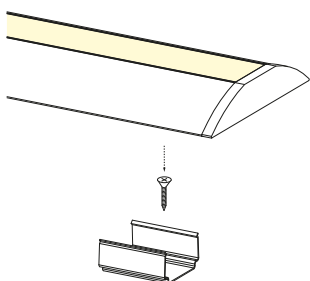

BASIC CODES

PAGG11

Steel clip for snapping onto flat surfaces. The clip hooks onto the rear slots, which will be perfectly adhered to the surface. 12xM2.5 screws included.

NB. We recommend No. 1 Clip per 500mm

Code example: VEIA Profile + 1000mm Length + Brushed Aluminium Finish = Code: PA.VELA.17

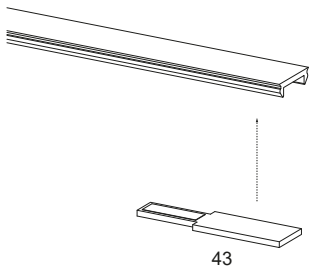

BASIC CODES

TC02

Rectangular electronic device with ON/OFF TOUCH system. The LED can be switched ON/OFF by gently touching the sensitive device section. To be installed inside the profile, in contact with the diffuser, with the double-sided tape supplied (12Vdc and 24Vdc 4A max.)

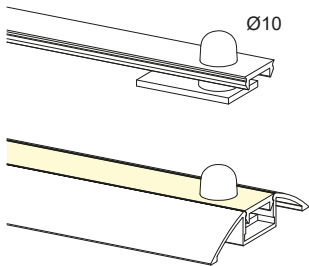

BASIC CODES

TC19

Rectangular electronic device with ON/OFF Sensor function. The Sensor system is motion-activated to switch ON the LED. If no movements are detected, the LED switches OFF. To be installed inside the profile, by drilling a Ø10mm hole on the diffuser (12Vdc and 24Vdc 4A max.)

Code example: VEIA Profile + 1000mm Length + Brushed Aluminium Finish = Code: PA.VELA.17



KITCHEN
WINE

YPSILON

Anodised aluminium 6060 extruded profiles, designed to be used in a wide range of configurations and situations. Their size, shape and easy of installation allow creating several types of sophisticated and prominent light outputs. Also, the many accessories make the extruded profile even more versatile, with the option of creating a customized light source. Ideal to house and dissipate LED Strips.

 EXTRUDED IN ITALY

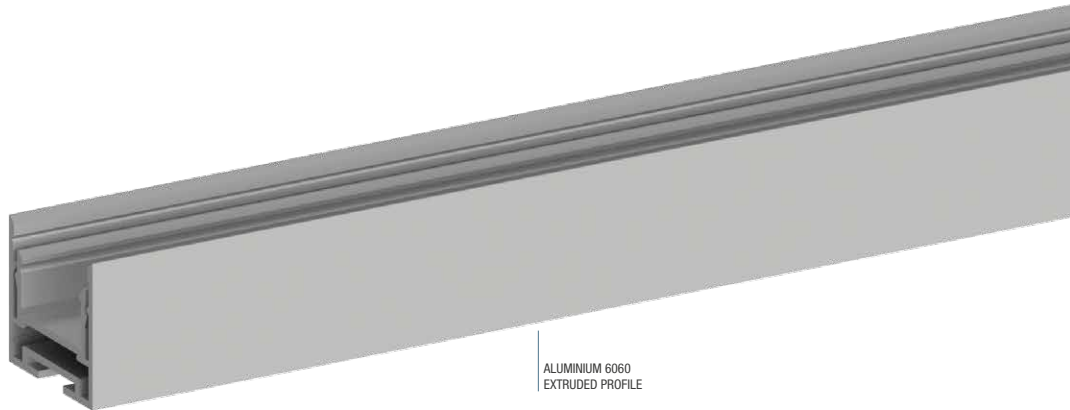

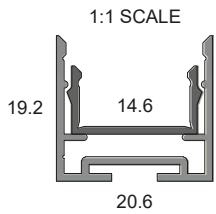

BASIC CODES

PA.YPSILON.

LENGTH

- 1 1000mm
- 2 2000mm
- 3 3000mm

FINISHES

- 1 Matt white RAL9003
- 2 Matt black RAL9005
- 7 Brushed aluminium

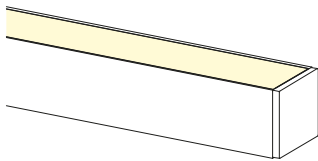
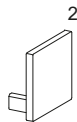
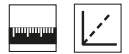

BASIC CODES

SY01.

FINISHES

- 1 White
- 2 Matt black
- 7 Brushed aluminium

Side aluminium closing support. Easy and quick to install, by exerting a slight side pressure.

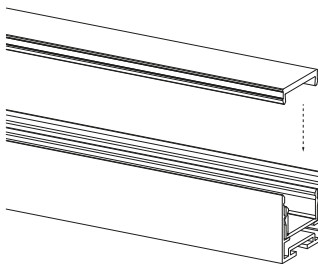

BASIC CODES

PA.20PE10.

LENGTH

- 1 1000mm brushed
- 2 2000mm brushed
- 3 3000mm brushed

- 1M 1000mm microprismatic
- 2M 2000mm microprismatic
- 3M 3000mm microprismatic

Brushed or microprismatic snap-on diffuser. The diffuser can be easily removed for maintenance operations.

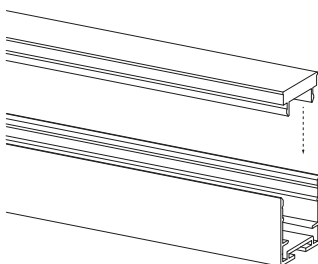

BASIC CODES

PA.20PE09.

LENGTH

- 1 1000mm brushed
- 2 2000mm brushed
- 3 3000mm brushed

Brushed snap-on walkable diffuser. The diffuser can be easily removed for maintenance operations.

Code example: YPSILON Profile + 1000mm Length + Brushed Aluminium Finish = Code: PA.YPSILON.17

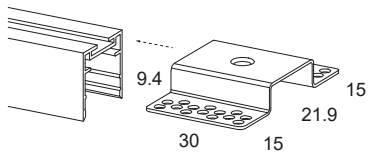

BASIC CODES

SY03

Support for RHO/Ypsilon profile flush-mounting installation. Install the support on the back of the profile and fix it to the 12mm plasterboard through self-tapping screws.

NB. We recommend No. 1 Support per 500mm

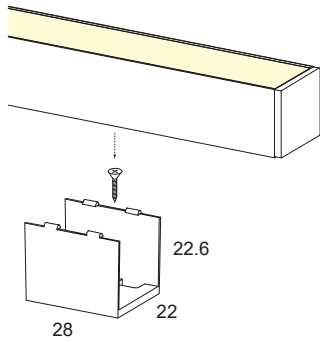

BASIC CODES

SY05.8

Transparent polycarbonate surface-mounted fixing clip for the RHO profile. It can be fixed on any surface. Supplied with M3x20 screw. Snap-in profile mounting.

NB. We recommend No. 1 Clip per 500mm

Code example: YPSILON Profile + 1000mm Length + Brushed Aluminium Finish = Code: PA.YPSILON.17



ZETA

Small-size anodized aluminium 6060 extruded profile, designed and produced to be installed on very thin surfaces. Extremely easy to install, thanks to the brushed snap-in diffuser and side supports. Ideal to house and dissipate LED Strips, and especially suited to illuminate and embellish kitchen and bathroom cabinets, under-wall cupboards, furniture, closets, shelves and display cases. It can also be surface-mounted and on plasterboard.

 EXTRUDED IN ITALY

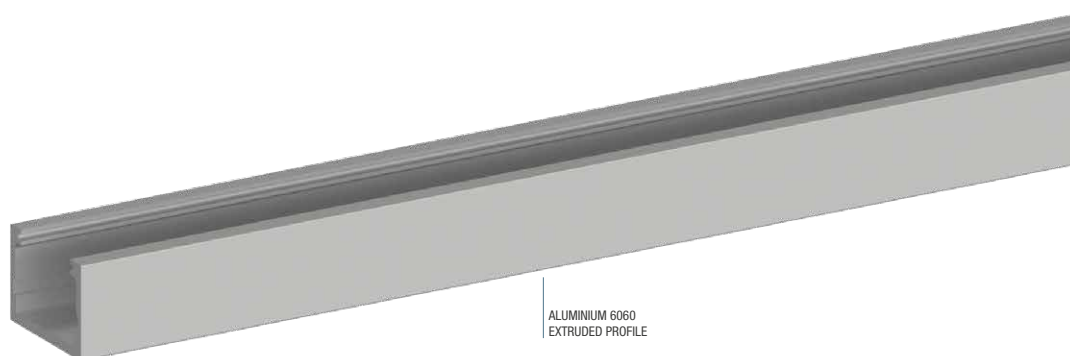

1:1 SCALE

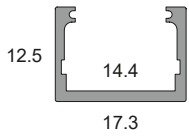

BASIC CODES

PA.ZETA.

LENGTH

- 1 1000mm
- 2 2000mm
- 3 3000mm

FINISHES

- 1 Matt white RAL9003
- 2 Matt black RAL9005
- 7 Brushed aluminium

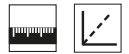

BASIC CODES

SZ01.

FINISHES

- 1 White
- 2 Matt black
- 5 Grey
- 7 Brushed aluminium

FUNCTIONS

- C** Closure and fixing

Hole fixing and closing side ABS support for M3x20 screw and cover cap.

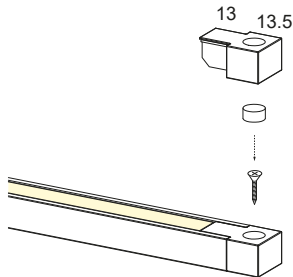

BASIC CODES

SZ01.

FINISHES

- 1 White
- 2 Matt black
- 5 Grey
- 7 Brushed aluminium

FUNCTIONS

- I** ON/OFF closure and fixing

Hole fixing and closing side ABS support for M3x20 screw, cover cap, and ON/OFF switch.

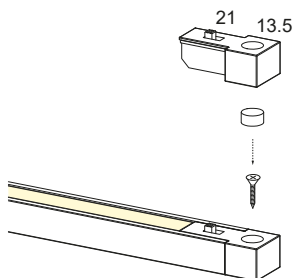

BASIC CODES

SZ01.

FINISHES

- 1 White
- 2 Matt black
- 5 Grey
- 7 Brushed aluminium

FUNCTIONS

- T** TOUCH closure and fixing

Hole fixing and closing side ABS support for M3x20 screw, cover cap, and ON/OFF Touch device. The LED can be switched ON with a slight touch. (12Vdc and 24Vdc - 4A max.)

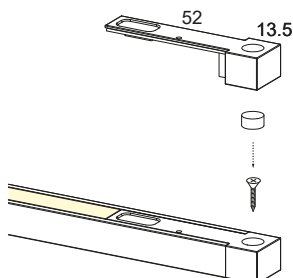

BASIC CODES

SZ01.

FINISHES

- 1 White
- 2 Matt black
- 5 Grey
- 7 Brushed aluminium

FUNCTIONS

- S** SENSOR closure and fixing

Hole fixing and closing side ABS support for M3x20 screw, cover cap, and ON/OFF Sensor device. The Sensor system is motion-activated to switch ON the LED. (12Vdc and 24Vdc - 4A max.) If no movements are detected, the LED switches OFF.

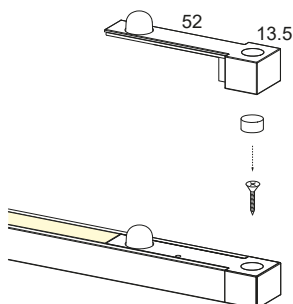

Code example: ZETA Profile + 1000mm Length + Brushed Aluminium Finish = Code: PA.ZETA.17

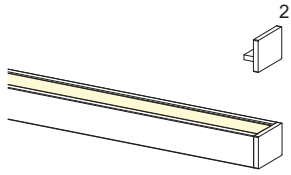

BASIC CODES

SZ201.

FINISHES

- 1 White
- 2 Matt black
- 5 Grey
- 7 Brushed aluminium

FUNCTIONS

- C** Closure

Side ABS closing support. Easy and quick to install, by exerting a slight side pressure.

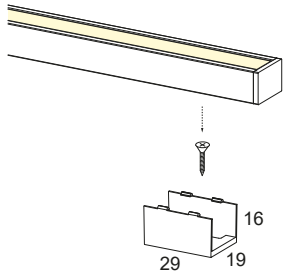

BASIC CODES

SZ02.8

Transparent polycarbonate surface-mounted fixing clip for the ZETA profile. It can be fixed on any surface. Supplied with M3x20 screw. Snap-in profile mounting.

NB. We recommend No. 1 Clip per 500mm

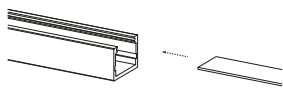

BASIC CODES

PA.02NA12.

LENGTH

- 1** 1000mm brushed
- 2** 2000mm brushed
- 3** 3000mm brushed

Brushed diffuser to insert on the profile internal slot. Supplied in strips of different sizes.

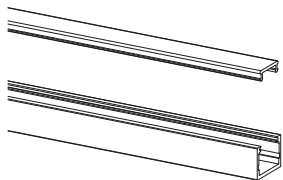

BASIC CODES

PA.07PE81.

LENGTH

- 1** 1000mm brushed
- 2** 2000mm brushed
- 3** 3000mm brushed
- 1T** 1000mm transparent
- 2T** 2000mm transparent
- 3T** 3000mm transparent

Transparent or brushed snap-on diffuser. The diffuser can be easily removed for maintenance operations.

Code example: ZETA Profile + 1000mm Length + Brushed Aluminium Finish = Code: PA.ZETA.17



SUSPENSION ACCESSORIES

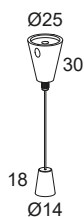

BASIC CODES

PD.TCE01.

Suspension mounting KIT with Ø1.2mm 3000mm rope. With the KIT, you can adjust the lamp distance from the ceiling.

FINISHES

■ 6 Chrome

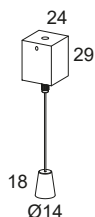

BASIC CODES

PD.TCE02.

Suspension mounting KIT with Ø1.2mm 3000mm rope. With the KIT, you can adjust the lamp distance from the ceiling.

FINISHES

- 1 White
- 2 Matt black
- 7 Brushed aluminium

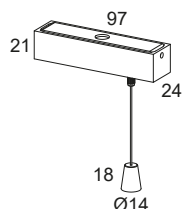

BASIC CODES

PD.TCE03.

Suspension mounting KIT with Ø1.2mm 3000mm rope. With the KIT, you can adjust the lamp distance from the ceiling.

FINISHES

- 1 White
- 2 Matt black
- 7 Brushed aluminium

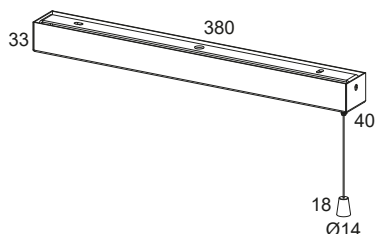

BASIC CODES

PD.TCE06.

Suspension mounting KIT with Ø1.2mm 3000mm rope. With the KIT, you can adjust the lamp distance from the ceiling and house an power supply inside it.

FINISHES

- 1 White
- 2 Matt black
- 7 Brushed aluminium

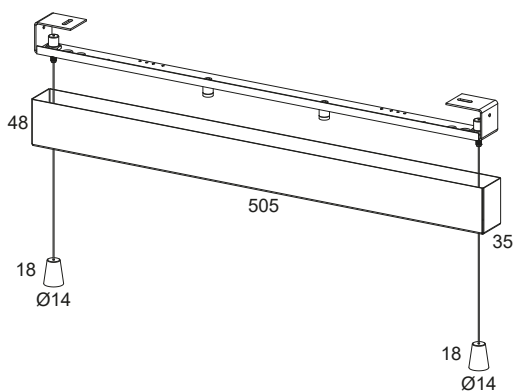

BASIC CODES

PD.TCE07.

Suspension mounting KIT with magnet and Ø1.2mm 3000mm rope. With the KIT, you can adjust the lamp distance from the ceiling and house an power supply inside it.

FINISHES

- 1 White
- 2 Matt black
- 7 Brushed aluminium

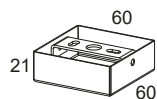

BASIC CODES

SK04.

Off-centred installation accessory. It allows housing the cables inside it, and it can be placed where needed.

FINISHES

- 1 White
- 2 Matt black
- 7 Brushed aluminium

JUNCTION BRACKETS

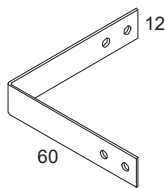

BASIC CODES

STA203

External steel bracket to create a vertical L-shaped fitting. M3x4 set-screws supplied.
Compatible with DELTA, RASO, RHO, YPSILON and TAU profiles.

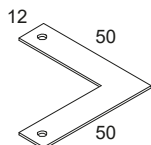

BASIC CODES

STA204

External steel bracket for fixing two 45°cut profiles. M3x4 set-screws supplied.
Compatible with DELTA, RASO, RHO, YPSILON and TAU profiles.

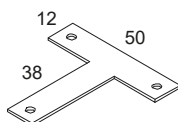

BASIC CODES

STA205

External steel bracket to create a T-shaped fitting. In this configuration, some material is removed from the profiles, to achieve an impeccable visual effect. M3x4 set-screws supplied.
Compatible with DELTA, RASO, RHO, YPSILON and TAU profiles.

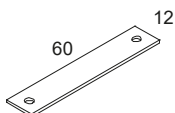

BASIC CODES

STA208

External steel bracket for fixing two in-line profiles. M3x4 set-screws supplied.
Compatible with DELTA, RASO, RHO, YPSILON and TAU profiles.

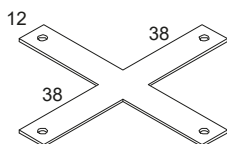

BASIC CODES

STA209

External steel bracket to create an X-shaped fitting. In this configuration, some material is removed from the profiles, to achieve an impeccable visual effect. M3x4 set-screws supplied.
Compatible with DELTA, RASO, RHO, YPSILON and TAU profiles.

MAGNETIC AND DOUBLE-SIDED TAPE



BASIC CODES

NM.

WIDTH

- L10** 10mm
- L15.** 15mm
- L20** 20mm

Magnetic adhesive tape for anodised aluminium profiles. Supplied on a 10-metre reel, 1.2mm thickness.
(Force of attraction >40g/cm².)

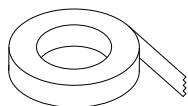

BASIC CODES

4965.

WIDTH

- 08** 8mm
- 16** 16mm

Double-sided adhesive tape for aluminium profiles and LED strips. Supplied on a 50-metre reel.





NANOLED LIGHTING

It is a brand of Tecnocavi Service srl
61021 Carpegna (PU) via Pian dei Roghi, 32
Tel. + 39 0722 77418
www.nanoledlighting.com

CONTACTS

Information office

info@nanoledlighting.com

Federico Francioni

Owner and Sales Manager
federico@nanoledlighting.com

Francesco Francioni Jr.

Italy Sales
commerciale@nanoledlighting.com

Fabrizio Francioni

Owner and Production Manager
fabrizio@nanoledlighting.com

Francesco Francioni

Owner and General Management
francesco@nanoledlighting.com

Francesca Severi

Head of Administration
amministrazione@nanoledlighting.com

Remo Giuliani

Technical and design office
tecnico@nanoledlighting.com

PROFILE TECHNICAL CATALOGUE 2024 Edition 01

Graphic design and realisation: Team Nanoled Lighting

Tecnocavi Service S.r.l. accepts no liability for printing errors, measurements and technical data. The company reserves the right to make changes to the products illustrated, at any time, without prior notice. Unauthorised reproduction or copying is prohibited.

www.nanoledlighting.com

